



SAMSUNG CAMERA

---

# User Manual

Digital Camera

## *Digimax U-CA 3*

Thank you for buying a Samsung Camera. This manual will guide you through using the Digimax U-CA 3, including taking images, downloading images and using the MGI PhotoSuite III SE software. Please read this manual before using your new camera.

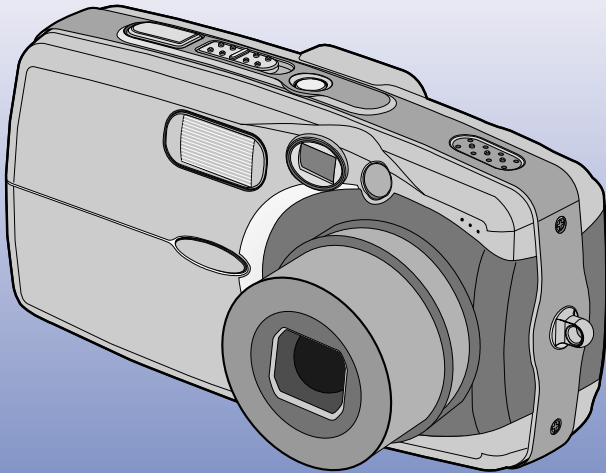

ENGLISH



# Instructions

- Use this camera in the following order

## Set up the camera driver

Before connecting the camera to a PC, via the USB cable, you will need to set up the camera driver. Install the camera driver that is contained in the Application S/W CD-ROM.(p.95)

## Take a picture

Take a picture (p.21)

## Insert the USB cable

Insert the supplied USB cable into the PC's USB port and the camera's USB connection terminal.(p.83)

## Check the camera's power

Check the camera's power  
If the power is turned off, press the camera button to power it on.(p.24)

## Check [Removable Disk]

Open Window's EXPLORER and search for [Removable Disk].(p.84)

- To play back a video shot with this camera, be sure to use the QuickTime player supplied on the software CD-ROM. Applications that do not support the MPEG-4 codec (e.g., Windows Media Player) may not be able to play back the video.
- If you use a card reader to copy the images on the memory card to your PC, the images could be damaged. When transferring the images taken with the camera to your PC, be sure to use the supplied USB cable to connect the camera to your PC. Please note that the manufacturer holds no responsibility for loss or damage of images on the memory card due to the use of a card reader.

# Contents

## READY

● Getting to know your camera .....	5
● About the icons .....	5
● Danger .....	6
● Warning .....	6
● Caution .....	7
● An FCC warning .....	7
● This digital camera can be used for .....	8
● Manufacturer's contents .....	10
● Identification of features .....	11
■ Front & Top .....	11
■ Back & Bottom .....	11
■ Side/ 5-function button .....	12
■ Mode switch .....	12
■ Lamp .....	13
● Connecting to a Power Source .....	13
■ Connecting to a Power Source .....	14
■ Using the batteries .....	15
■ Removing the battery .....	15
■ Using the Digimax battery pack (Optional : SBP-3603, 3.3V) .....	15
● Precautions on Using the Memory Stick Duo16	
● Inserting the memory card .....	18
● Removing the memory card .....	18
● When Using the Camera for the First Time	19

## RECORDING

● LCD monitor indicator .....	20
● Starting the recording mode .....	21
● Things to watch out for when taking pictures	23
● Using the camera buttons to adjust the camera .....	24

■ POWER button .....	24
■ SHUTTER button .....	24
● WIDE/TELE button .....	24
● Voice memo/UP button .....	26
■ Recording a voice memo .....	26
● Macro/Down button (Focusing) .....	27
● Focus lock .....	28
● FLASH/LEFT button .....	28
● Self-timer/Right button .....	30
● MENU/OK button .....	31
● +/- button .....	31
● LCD button .....	35
● Using the LCD monitor to adjust the camera settings .....	36
● How to use the menu .....	37
● Mode .....	38
● Size .....	38
● Quality .....	39
● Metering .....	40
● Effect .....	40
● Sharpness .....	41

## PLAY

● Starting play mode .....	42
■ Playing back a still image .....	42
■ Playing back a movie clip .....	43
■ Playing back a recorded voice .....	43
● LCD monitor indicator .....	44
● Using the camera buttons to adjust the camera .....	45
■ Thumbnail/Enlargement button .....	45
● Voice memo/Up button .....	46
● Play & Pause/Down button .....	47

# Contents

●LEFT/RIGHT/MENU/OK button .....	48	●Selecting Video out type .....	70
●LCD button .....	48	●Quick view .....	71
●Delete button .....	49	●Connecting an External Device(USB) .....	72
●Setting up the play back function using the LCD monitor .....	50	●Initialization(RESET ALL) .....	72
●Deleting all images .....	52	●Setting up the MYCAM menu .....	73
●Protecting images .....	52	●Avatar .....	73
●Starting the slide show .....	53	●Start up image .....	75
●Resize .....	54	●Start up sound .....	76
●Rotating an image .....	55	●Shutter sound .....	76
●DPOF: PRINT ORDER .....	55	●List of camera functions .....	77
●DPOF: STANDARD .....	56	●Starting PC mode .....	83
●DPOF: INDEX .....	56	●Important notes .....	85
●DPOF: PRINT SIZE .....	57	●Warning indicator .....	87
●DPOF: CANCEL .....	57	●Before contacting a service center .....	88
●PictBridge .....	58	●Specifications .....	91
●PictBridge: Picture Selection .....	59		
●PictBridge: Print Setting .....	60		
●PictBridge: Picture Printing .....	61		
●PictBridge: DPOF AUTO PRINT .....	62		
●PictBridge: RESET .....	62		

<b>SETUP</b>	
●Setup menu .....	63
●File name .....	64
●Auto power off .....	65
●Language .....	66
●Formatting a memory card .....	66
●Setting up the Date/Time/Date type .....	67
●Imprinting the recording date .....	67
●Function lamp .....	68
●Sound .....	69
●LCD brightness .....	69

<b>SOFTWARE</b>	
●Software Notes .....	93
●About the software .....	93
●Setting up the application software .....	95
●DigiStudio Installation guide .....	103
●DigiStudio Installation .....	105
●Removing the USB Driver for Windows 98SE .....	108
●Removable Disk .....	109
●Removing the removable disk .....	110
■Setting up the USB Driver for MAC .....	111
■Using the USB Driver for MAC .....	111
●Digimax Viewer 2.1 .....	112
●MGI PhotoSuite III SE .....	113
●FAQ .....	123

# Getting to know your camera

Thank you for buying a Samsung Digital Camera.

- Prior to using this camera, please read the user manual thoroughly.
- When you require After Sales service, please bring the camera and the cause of the camera malfunction (such as Batteries, Memory card etc.) to the A/S center.
- Please check that the camera is operating properly prior to when you intend to use it (e.g. for a trip or an important event) to avoid disappointment. Samsung camera takes no responsibility for any loss or damages that may result from camera malfunction.
- Keep the manual in a safe place.
- \* Microsoft, Windows and Windows logo are registered trademarks of Microsoft Corporation incorporated in the United States and/or other countries.
- \* Apple, Mac and QuickTime logo are registered trademarks of Apple computer.
- \* Memory Stick Duo is a registered trademark of Sony Corporation.
- \* All brand and product names appearing in this manual are registered trademarks of their respective companies.

## About the icons

This manual contains instructions on using this camera that will help you to use this camera safely and correctly. This will help prevent danger and injury to others.



### DANGER

DANGER indicates an imminently hazardous situation which, if not avoided, will result in death or serious injury.



### WARNING

WARNING indicates a potentially hazardous situation, which, if not avoided, could result in death or serious injury.



### CAUTION

CAUTION indicates a potentially hazardous situation, which, if not avoided, may result in a minor or moderate injury.

# Danger

- Do not attempt to modify this camera in any way. This may result in fire, injury, electric shock or severe damage to you or your camera. Internal inspection, maintenance and repairs should be carried out by your dealer or Samsung Camera Service Center.
- Please do not use this product in close proximity to flammable or explosive gases, as this could increase the risk of explosion.
- Should any form of liquid or a foreign object enter the camera, do not use it. Switch off the camera, and then disconnect the power source (batteries or AC Power Adapter). You must contact your dealer or Samsung Camera Service Center. Do not continue to use the camera as this may cause a fire or electric shock.
- Do not insert or drop metallic or inflammable foreign objects into the camera through access points e.g. the memory card slot and battery chamber. This may cause a fire or electric shock.
- Do not operate this camera with wet hands. This could pose a risk of electric shock.

# DANGER

## Warning

- Do not use the flash in close proximity to people or animals. Positioning the flash too close to your subject's eyes, may cause eyesight damage.
- When taking photographs, never point the lens of the camera directly into very strong light. This may result in permanent damage to your eyesight.
- For safety reasons keep this product and accessories out of reach of children or animals to prevent accidents e.g.:
  - Swallowing batteries or small camera accessories. If an accident should occur, please consult a doctor immediately.
  - There is the possibility of injury from the camera's moving parts.
- Batteries and camera may become hot during prolonged use and it may result in camera malfunction. Should this be the case, allow the camera to sit idle for a few minutes to allow it time to cool.
- Do not recharge non rechargeable batteries. This may cause an explosion.
- Do not leave this camera in places subject to extremely high temperatures, such as a sealed vehicle, direct sunlight or other places of extreme variances in temperature. Exposure to extreme temperatures may adversely affect the camera's internal components and could cause a fire.
- When in use, do not cover the camera or AC Power Adapter. This may cause heat to build up and distort the camera body or cause a fire. Always use the camera and its accessories in a well-ventilated area.

# Caution

- Leaking, overheating, or burst batteries could result in fire or injury.
  - Use batteries with the correct specification for the camera.
  - Do not short circuit, heat or dispose of batteries in fire.
  - Do not insert the batteries with the reverse polarities.
- Remove the batteries when not planning to use the camera for a long period of time. Batteries may leak corrosive electrolyte and irreparably damage the camera's components.
- Do not fire the flash while it is in contact with hands or objects. Do not touch the flash after using it continuously. It may cause burns.
- Do not move the camera while it is switched on, if you are using the AC Power Adapter. After use, always switch off the camera before unplugging the adapter from the wall socket. Then make sure that any connector cords or cables to other devices are disconnected before moving the camera. Failure to do so may damage the cords or cables and cause a fire or electric shock.

## CAUTION

### An FCC warning

- This device has been tested in accordance with the limits of a class B digital device under item 15 of the FCC rules. These limits are designed to provide protection against harmful interference in commercial installation. This equipment generates, absorbs and can emit radio frequency energy. If it is not installed and used in accordance with the instructions, it may cause harmful interference to radio communication. There is however, no guarantee that interference will not occur in some situations. Should any interference occur when this device is in operation, please try one or more of the following measures.
  - Change the location and direction of any aerial.
  - Increase distance between the camera and the affected device.
  - Use a different socket away from the affected device.
  - Please contact a Samsung agent or a radio/TV engineer.
- This device complies with part 15 of the FCC Rules.
- Changes or modifications not expressly approved by the party responsible for compliance could void user's authority to operate the equipment.

# This digital camera can be used for

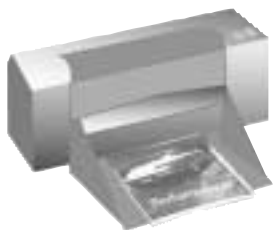

Printing images using a dedicated printer, DPOF and PictBridge compatible printer or a DPOF-equipped photo lab. (refer to page 55~62)



Viewing images on a TV. (refer to page 70)



Down loading image files from camera to computer. (refer to page 84)



Taking a picture. (refer to page 20~41)



Editing images on a PC. (refer to page 113)



# This digital camera can be used for

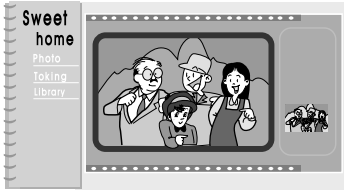

Creation of a digital photo album.

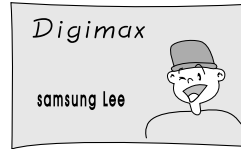

Taking a self-portrait and using the image to personalize name cards.



Recording your voice.  
(refer to page 22)



Recording a movie clip  
(refer to page 21)

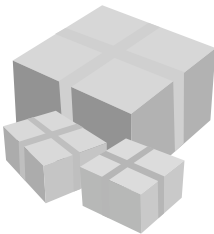

You can even create your own unique gift wrap paper by using your digital images.



Inserting images directly into any electronic document.

# Manufacturer's contents

Please check that you have the correct contents before using this product.

 marked contents are optional.

Digital Camera

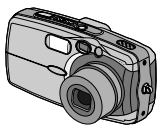

Pouch



AV cable



USB cable



Camera strap



User manual



Product warranty



Software CD



DigiStudio



Duracell CP-1  
battery

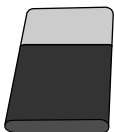

Memory Stick Duo/  
Case/Adapter



Battery pack  
(SBP-3603)



AC adapter (3.3V)



## Digimax Battery Pack : SLB-1037 KIT

Battery charger

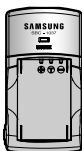

Rechargeable battery



Cigar jack for a car



User manual



# Identification of features

## Front & Top

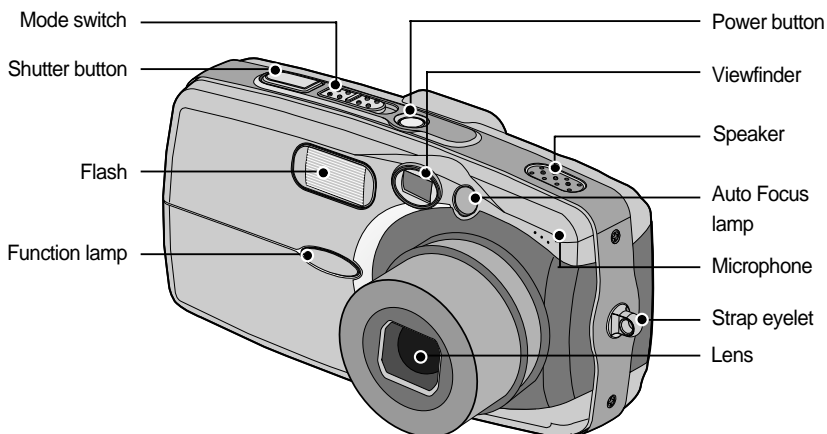

## Back & Bottom

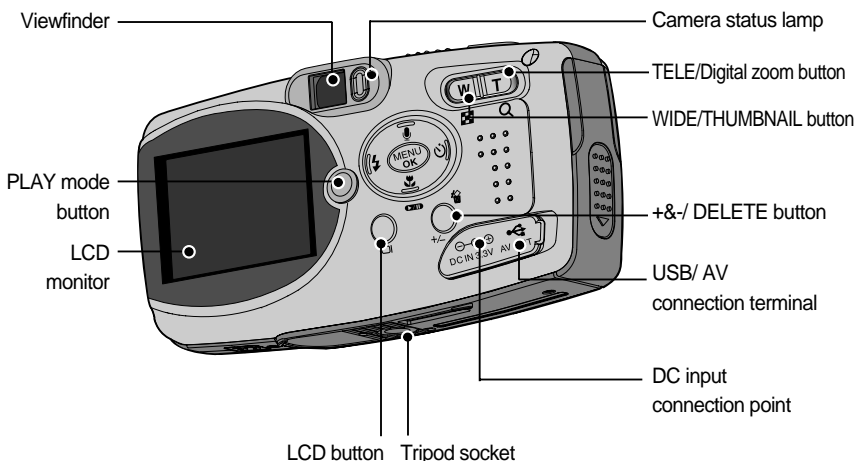

\* When using the digital zoom to take a picture, the composition of the picture may be different depending on whether you are using the LCD monitor or the viewfinder. The picture will be taken in the composition of the picture as it appears on the LCD monitor.

# Identification of features

## Side/ 5-function button

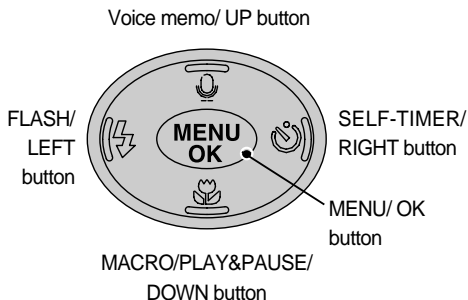
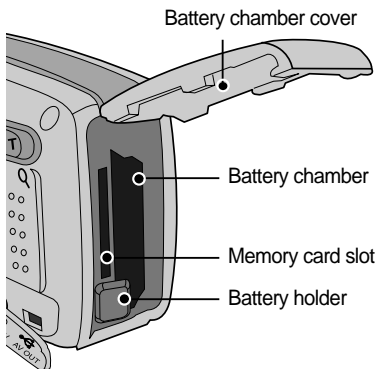

## Mode switch

■ You can select the desired working mode by using the mode switch located on the top of the camera. This digital camera has 3 recording modes. These are listed below.

### ● Movie clip mode

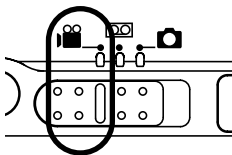

A movie clip can be recorded for as long as the available recording time of the memory capacity allows.

Image size and type are listed below.

- Image size : 320X240, 160X120

- Movie clip file type : \*.mov (MPEG4)

### ● Voice recording mode

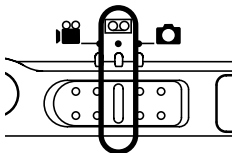

A voice recording can be recorded for as long as the available recording time of the memory capacity allows.

(Max: 1 hour)

- File type : \*.wav(G. 711)

# Identification of features

## ● Still image mode

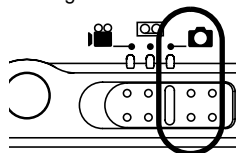

You can select from Auto, Manual, or Night mode. In Myset mode, any changes made to settings other than Self-Timer and Voice Recording will be maintained even after the camera is turned off.

## Lamp

Type	Operation Lamp	Camera Status Lamp	LCD Monitor
When turning on the power	7 color lights blink and then turns off when the camera is ready to take a picture	Blinks orange once	X
When the camera is in focus (when the SHUTTER button is pressed halfway)	X	Green lamp lights up	Autofocus mark lights up green
When the camera is out of focus (when the SHUTTER button is pressed halfway)	X	Green lamp blinks	Autofocus mark lights up red
While the flash is charging	X	Red lamp blinks	X
Flash is ready (when the SHUTTER button is pressed halfway)	X	Orange lamp lights up	X
While saving an image	X	Green lamp blinks	X
While shooting a video	Purple lamp blinks at a 1-second interval	X	Auto focus frame : White
During voice recording	Blue lamp blinks at a 1-second interval	X	X
While the camera is connected to a PC	X	Green lamp lights up	X
While transferring data between the camera and a PC	X	Green lamp blinks	X
When shooting an image	Green lamp blinks once for 0.3 second	X	X
While the self-timer is running	Red lamp blinks for 7 seconds at a 1-second interval/blinks for 3 seconds at a 0.25 second interval	X	X
When the LCD monitor is turned off in Still Image mode	X	Green lamp lights up	X

## Connecting to a Power Source

- There are two ways in which to provide the camera with power. You can use batteries or alternatively, you can use an AC(100 ~ 250V) Adapter (DC 3.3V 2.0A).
- We recommend using batteries for a digital camera.  
(use batteries that are within a year of their date of manufacture) The batteries are listed below.  
Non rechargeable batteries : Duracell CP-1 battery  
Rechargeable batteries : Digimax power pack (SLB-1037)  
Battery pack : Digimax Battery Pack (SBP-3603)

# Connecting to a Power Source

## INFORMATION

### Important information about battery usage

- Do not recharge the non rechargeable batteries. This may cause an explosion.
- Please remove the batteries if the camera will not be used for long periods.
- Batteries can lose power over time and are prone to leaking if kept inside the camera.
- Low temperatures (below 0 °C) can affect the performance of the batteries and you may experience reduced battery life.
- Batteries will usually recover at normal temperatures.
- During extended use of the camera, the camera body may become warm. This is perfectly normal.
- If you are planning to use this camera for long periods of time, it is advisable to use an AC adapter (3.3V 2.0A).

### Using the AC power adapter (3.3V 2.0A)

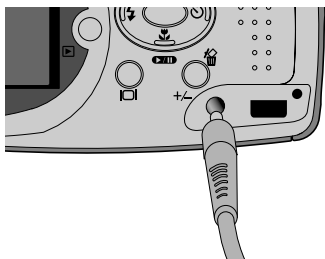

If you have access to a mains supply, using an AC Adapter (3.3V 2.0A) allows the camera to be used for long periods of time.

Plug the adapter into the connection point (DC IN 3.3V) on the camera.

Remove the batteries from the camera when using an AC adapter.



## DANGER

- Always turn off the power before taking the AC adapter out of the mains supply.
- As with all mains powered devices, safety is important. Ensure that neither the camera nor adapter comes into contact with water or metallic materials.
- Please ensure that you use an AC adapter (3.3V 2.0A) with the correct specification for the camera. Failure to do so may affect your warranty.

# Connecting to a Power Source

## Using the batteries

: If the camera does not turn on after you have inserted batteries, please check whether the batteries are inserted with the polarity(+ and -).

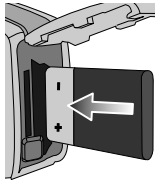

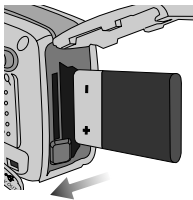

1. Open the battery chamber cover by pushing in the direction of the arrow.
2. Insert the batteries according to the polarity marks (+ and -) on the back of the battery chamber cover.
3. To close the battery chamber cover, push it until it clicks.

## Removing the battery



1. Turn off the camera power. Open the battery chamber cover and move the battery holder aside. The battery will be released.
2. Take out the battery and close the battery chamber cover.

■ There are 3 indicators for battery condition that are displayed on the LCD monitor.

Battery indicator			
Battery status	The batteries are fully charged.	Prepare new batteries.	There is no battery capacity. Replace with new batteries.

## Using the Digimax battery pack ( Optional : SBP-3603, 3.3V)

The Digimax Battery Pack is a rechargeable external Li-ion battery for use with most digital cameras. These optional battery packs provide long lasting power and their operating performances are much improved over Ni-MH and Alkaline batteries. This is due to the mass storage lithium ion cell. Refer to the illustrations

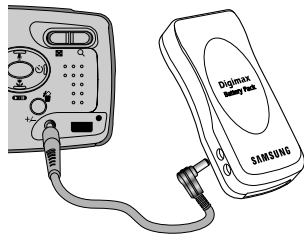

# Precautions on Using the Memory Stick Duo

This camera operates only with a Memory Stick Duo.

Some models of Memory Stick Duo media do not have the write-protect switch (B).

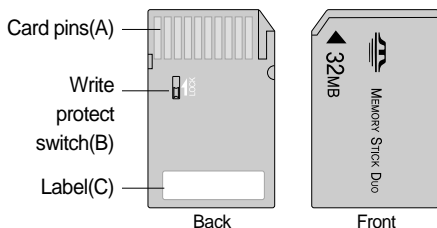

[ Memory Stick Duo ]

- Do not touch the card pins (part A) with your fingers or with metal objects.
- Do not press hard when writing on the label (part C).
- If you insert the Memory Stick Duo into the Memory Stick Duo adapter, you will be able to use it with a Memory Stick-compatible device.

- Do not insert the Memory Stick Duo on its own into a Memory Stick-compatible device.
- Do not insert the Memory Stick Duo adapter into a Memory Stick-compatible device without attaching the Memory Card Duo to the adapter. Using it without the Memory Stick Duo may adversely affect the device into which it is inserted.
- Be sure to check the proper direction of insertion before use .
- Insert the Memory Stick Duo all the way into the Memory Stick Duo adapter.  
If the Memory Stick Duo is not inserted correctly into the adapter, it may not operate properly.
- Do not attach labels to any part of the Memory Stick Duo and Memory Stick Duo adapter. The labels may come off as you insert the Memory Stick Duo into the adapter or into a Memory Stick-compatible device.
- When inserting the Memory Stick Duo into the slot, do not force or bend it.
- Do not touch the Memory Stick Duo adapter's card pins with your fingers or with metal objects.
- Do not allow dirt or foreign material to get into the Memory Stick Duo adapter slot.
- Do not leave the Memory Stick Duo with its adapter in areas subject to high temperatures.
- Those models with the write-protect switch on the back of the card prevents accidental erasure of data from deletion or formatting. By sliding the switch to the top of the memory card, the data will be protected. By sliding the switch to the bottom of the memory card, the data protection ability will be canceled. Please use a pointed object to move the write-protect switch. Slide the switch to the bottom of the memory card before taking a picture.



# Precautions on Using the Memory Stick Duo

## ■ Maintenance of the Memory Stick Duo

(Hereafter the Memory Stick Duo is referred to as the "Memory Card".)

Be sure to format the memory card (see p. 66) if you are using a newly purchased memory for the first time, if it contains data that the camera cannot recognize, or if it contains images captured with a different camera.

- Turn off the camera power whenever the memory card is being inserted or removed.
- Repeated use of the memory card will eventually reduce the memory card's performance. Should this be the case, you will need to purchase a new memory card.  
Wear and tear on the memory card is not covered by the Samsung warranty.
- The memory card is an electronic precision device. Do not bend, drop or subject the memory card to any heavy impact.
- Do not store the memory card in an environment with strong electronic or magnetic fields, e.g. near loud speakers or TV receivers.
- Please do not use or store in an environment where there are extremes in temperature.
- Do not allow the memory card to become dirty or to come into contact with any liquid. Should this happen, clean the memory card with a soft cloth.
- Please keep the memory card in its case when not in use.
- During and after periods of extended use, you may notice that the memory card is warm. This is perfectly normal.
- Do not use a memory card that has been used in another digital camera or memory card reader.
- Do not use a memory card formatted by another digital camera or memory card reader.

## ■ Preserving the memory card data

- Do not remove the memory card while the camera status lamp (green) is blinking.  
Doing so will corrupt the data on the memory card.
- Samsung cannot be held responsible for lost data.
- It is advisable to copy important data onto other media as back-up e.g. floppy disks, hard disks, CD etc.
- If there are no shots remaining  
When you press the shutter button, a [CARD FULL !] message is displayed and the camera will not operate. To optimize the amount of memory in the camera, replace the memory card or delete unnecessary images stored in the memory.

# Inserting the memory card

1. Turn off the camera's power and pull the memory card cover in the direction of the arrow to open.

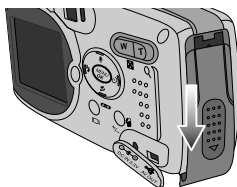

2. Have the front of the memory card facing toward the front of the camera (lens) and the card pins toward the back of the camera (LCD monitor), and then push the memory card into the card slot until you hear a click.

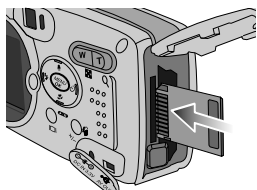

3. To close, push the card cover until you hear a click. If the memory card does not slide in smoothly, do not attempt to insert it by force. Check the direction of insertion, and then insert it correctly.

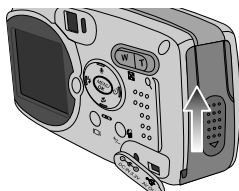

## INFORMATION

- Do not insert the memory card the wrong way round . Doing so may damage the memory card slot.

## Removing the memory card

1. Turn the power off using the power button.  
Open the battery chamber cover and press the memory card as shown in the image and release.
2. Remove the memory card and close the memory card cover.

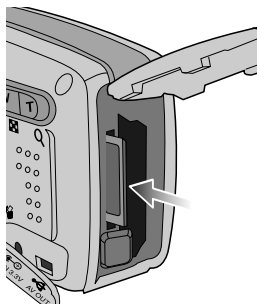

# When Using the Camera for the First Time

■ If the camera is turned on for the first time, a menu will be displayed to set date, time and language in the LCD monitor. This menu will not be displayed after setting up the date, time and language. Set up the date, time and language before using this camera.

● Setting up the date, time and date type

1. Select the [DATE.TIME] menu by pressing the UP/DOWN button and press the RIGHT button.
2. Select the desired sub menu by pressing the UP/ DOWN/ LEFT/ RIGHT button.

RIGHT button : selects YEAR/ MONTH/ DAY/ HOUR / MINUTE/DATE TYPE

LEFT button : Moves the cursor to the [DATE/TIME] main menu if the cursor is at the first item of the date and time setup. In all other instances, the cursor will be shifted to the left of its current position.

UP/ DOWN button : changes the value of each item.



## INFORMATION

- Date setting range : 2003/01/01 ~ 2050/12/31

(Leap years and months are corrected automatically)

- You will need to check and select the correct Date / Time when the batteries have been removed for a period longer than 1 hour.

● Setting up the language

1. Select the [LANGUAGE] menu by pressing the UP/DOWN button and press the RIGHT button.
2. Select the desired sub menu by pressing the UP/ DOWN button and press the OK button. When the settings are complete, press the MENU button twice to exit the menu screen.



## INFORMATION

- You can select 16 languages. These are listed below.English, Korean, T. Chinese, S. Chinese, Japanese, Russian, Germany, Spanish, French, Italian, Danish, Dutch, Swedish, Finnish, Portuguese, Thai.
- Even if the camera is restarted, the language setting will be maintained.

# LCD monitor indicator



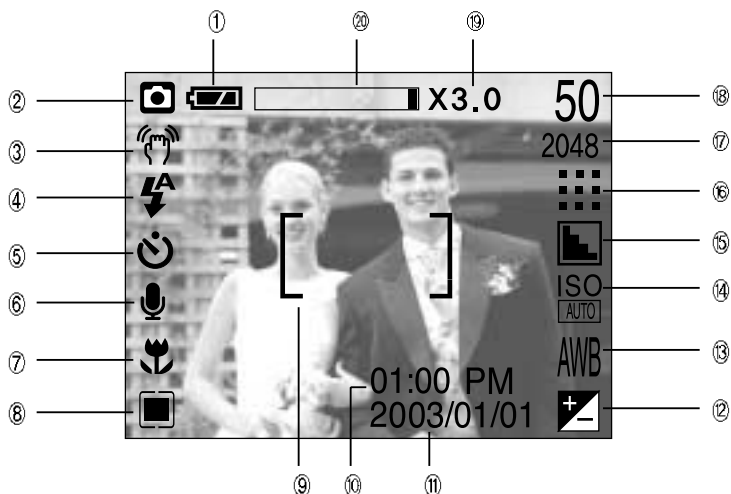







■ The LCD monitor displays information about the shooting functions and selections.



[ Image & Full Status ]

No.	Description	Icons	Page
1	Battery		p.15
2	Recording mode		p.12~13
3	Camera shake warning		p.23
4	Flash		p.29
5	Self-timer		p.30
6	Voice memo		p.26
7	Macro		p.27
8	Metering		p.40
9	Auto focus frame	[ ]	
10	Time	01:00 PM	p.19, 67
11	Date	2003/01/01	p.19, 67
12	Exposure compensation	LT	p.31
13	White Balance	AWB	p.32

# LCD monitor indicator

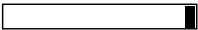
14	ISO	   	p.33
15	Sharpness	  	p.41
16	Image quality	  	p.39
17	Image size	2048, 2048P, 1600, 1024, 640	p.38
18	Number of available shots remaining	50	
	Remaining time( Movie clip/ Voice recording)	00:05:00	p.21
19	Digital Zoom rate	X3.0	p.25
20	Optical zoom		

## Starting the recording mode

### ■ Recording a Movie clip

1. Insert the batteries (p.15). Insert the batteries taking note of the polarity (+ / -).
2. Insert the memory card (p.18).
3. Close the memory card cover.
4. Press the power button to turn on the camera.
5. Select the MOVIE CLIP(  ) mode by sliding the mode switch.
6. Point the camera towards the subject and compose the image by using either the viewfinder or LCD monitor.
7. Press the shutter button to take a movie clip.

Press the shutter button once and movie clips are recorded for as long as the available recording time allows. Movie clips will still be recorded if the shutter button is released. If you wish to stop recording, press the shutter button again. Image size and type are listed below.

- Image size : 320X240, 160X120(Selectable)
- File type : \*.mov (MPEG4)

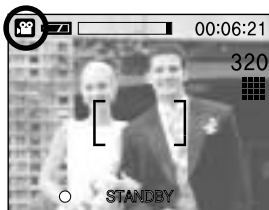
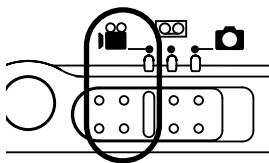

[ MOVIE CLIP mode ]

## INFORMATION

- The available recording time may vary depending on shooting conditions and camera settings.

# Starting recording mode

## ■ Recording Voice

Steps from 1-4 are the same as those for recording a movie clip.

5. Select the VOICE RECORDING(  ) mode by sliding the mode switch.

6. Press the shutter button to record a voice.

- Press the shutter button once and voice is recorded for as long as the available recording time(Max : 1 hour) allows. The recording time will be displayed on the LCD monitor.
- Voice will still be recorded if the shutter button is released.
- If you wish to stop recording, press the shutter button again.
- File type : \*.wav

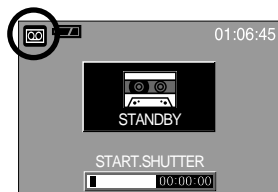
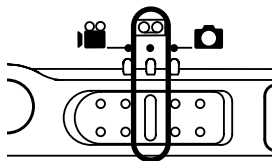

[ VOICE RECORDING mode ]

## INFORMATION

- A distance of 40cm between you and the camera (microphone) is the best distance to record sound.

## ■ Recording a still image

Steps from 1-4 are the same as those for recording a movie clip.

5. Select the STILL IMAGE(  ) mode by sliding the mode switch.

6. Point the camera towards the subject and compose the image by using either the viewfinder or LCD monitor.

7. Press the shutter button to capture an image.

- ※ A [DELETE?] message may be displayed after taking a picture. Refer to p.49 for more information about this [DEL. ANSWER].

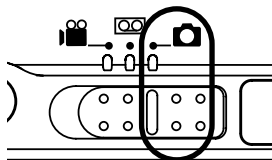

[ STILL IMAGE mode ]

## INFORMATION

- Manner mode: Pressing the power button for more than 3 seconds changes the buzzer and start-up sound setting to OFF, even though you may have set these to ON. To turn on the startup sound and operation sound, set the startup sound (MyCAM mode) and operation sound (Setup mode) to a submenu other than [OFF].

# Things to watch out for when taking pictures

## INFORMATION

- If the camera is in focus, when you press the SHUTTER button halfway, the camera status lamp (green) will light up and the LCD monitor's autofocus mark will turn green. If the camera is out of focus, when you press the SHUTTER button halfway, the camera status lamp (green) will blink and the LCD monitor's autofocus mark will turn red. Should this be the case, the camera is unable to capture an image clearly.
- If the camera status lamp (orange) lights up when you press the SHUTTER button halfway, the camera is in focus and you can use the flash also.  
The camera status lamp (red) blinks while the flash is charging.  
The camera status lamp (green) blinks while saving a picture to the memory card and turns off when saving is finished.
- When the Flash Off or Slow synchro mode is selected in a low lighting condition, the camera shake warning indicator (  ) may appear on the LCD monitor. In this case, use a tripod, support the camera on a solid surface or change the flash mode to flash shot mode.
- Backlight compensated shots : When taking an outdoor shot, avoid facing the sun, as the image may be dark because of the strong backlight. In backlight conditions, please use Fill-in flash(p.29), Spot metering(p.40) or Exposure compensation(p.31).
- Avoid obstructing the lens or the flash when you capture an image.
- As there can be some differences between what is seen through the Viewfinder and the resulting image when taken at a range closer than 1.5m, it is recommended that you use the LCD monitor to compose these shots.
- Using the LCD monitor extensively will drain the batteries.  
We recommend turning off the LCD monitor and using the optical viewfinder as often as possible in order to extend battery life.
- Under certain conditions the auto focus system may not perform as expected.
  - When photographing a subject that has little contrast.
  - If the subject is highly reflective or shiny.
  - If the subject is moving at high speed.
  - When there is strong reflected light, or when the background is very bright.
  - When the subject matter has only horizontal lines or the subject is very narrow (such as a stick or flagpole).
  - When the surroundings are dark
  - If the subject is the same colour as the background

# Using the camera buttons to adjust the camera

- The RECORDING(STILL IMAGE, VOICE RECORDING, MOVIE CLIP) mode function can be set up by using the camera buttons.

## POWER button

- Used for turning the camera's power on / off.
- If there is no operation during the specified time, the camera's power will be turned off automatically to save battery life. Pressing the power button for over 3 seconds will deactivate the buzzer sound function.

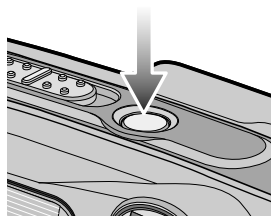

## SHUTTER button

- Used for taking an image or recording voice in the RECORDING (STILL IMAGE, VOICE RECORDING, MOVIE CLIP) mode.
- In MOVIE CLIP mode : Pressing the shutter button down fully starts the process for recording a movie clip. Press the shutter button once and the movie clip is recorded for as long as the available recording time in the memory allows. If you wish to stop recording, press the shutter button again.
- In STILL IMAGE mode  
Pressing the shutter button down halfway activates the autofocus and checks the condition of the flash. Pressing the shutter down fully takes the image and stores the relevant data regarding the shot. If you select voice memo recording, the recording will start after the camera has finished storing the image data.

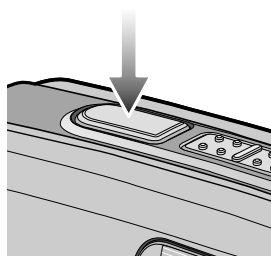

## WIDE / TELE button

- If the menu is displayed in Still Image mode, pressing the WIDE(W)/TELE(T) button will skip 5 menu tabs at a time.
- If the menu is not displayed, this button works as the OPTICAL ZOOM or DIGITAL ZOOM button.
- This camera has a 3X optical zoom and a 3X digital zoom function. Using both will offer a total zoom ratio of 9X.  
When you press the zoom (W/T) button, the zoom bar will display in the upper center part of the LCD monitor.

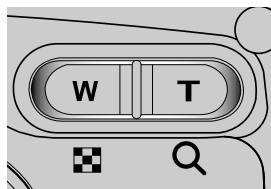



# WIDE / TELE button

## ● TELE Zoom

Optical zoom TELE : Pressing the zoom button T. This will zoom into the subject i.e. the subject will appear nearer.

Digital zoom TELE : When the maximum (3X) optical zoom is selected, pressing the zoom button T activates the digital zoom software. Releasing zoom button T stops the digital zooming at the required setting. Once the maximum digital zoom (3X) is achieved, pressing the zoom button T will have no effect. You can check the digital zoom rate with the [X1.5 ~ X 3.0] numerical mark next to the zoom bar.

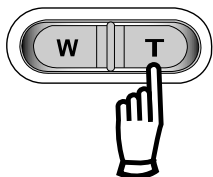

## ● WIDE Zoom

Optical zoom WIDE : Pressing the zoom button W. This will zoom out from the subject i.e. the subject will appear further away. Pressing the W button continuously will set the camera to its minimum zoom setting i.e. the subject appears at its furthest from the camera.

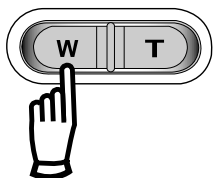

Digital zoom WIDE : When the digital zoom is in operation, pressing the zoom button W will reduce the digital zooming in steps. Releasing zoom button W stops digital zooming. Pressing the W button will reduce the digital zoom and then it will continue to reduce the optical zoom until the minimum setting is reached.

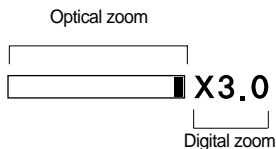



# WIDE / TELE button

## INFORMATION

- To use the digital zoom the LCD monitor has to be turned on.
- Images taken using the digital zoom may take a little longer for the camera to process. Allow time for this to take place.
- The digital zoom cannot be used in movie clip shots.
- Digital Zoom will not work in Night Scene mode.
- You may notice a decrease in image quality when using the digital zoom.
- When the maximum(3X) optical zoom is selected, pressing the zoom button T increases the digital zoom ratio by 0.5 steps.
- If the movie clip is being recorded, the zoom operation cannot be activated.
- Take care not to touch the lens to avoid taking an unclear image and possibly causing camera malfunction.  
If the image is dim, turn the camera power off and on again to modify the lens position.
- Take care not to press the lens as this may cause a camera malfunction.
- When the camera is turned on, take care not to touch the camera's moving lens parts as this may cause the resulting image to be dim and unclear.
- Take care not to touch the lens during zoom operation as this may cause damage.

## Voice memo( ) / UP button

- While the menu is showing, press the UP button to move up the submenu cursor.
  - When the menu is not displayed on the LCD monitor, the UP button operates as the voice memo(  ) button. You can add your voice-over to a stored still image.
- Recording a voice memo
1. Select the STILL IMAGE mode by sliding the mode switch.
  2. Press the VOICE MEMO(  ) button. If the voice memo indicator is displayed on the LCD monitor, the setting is completed.

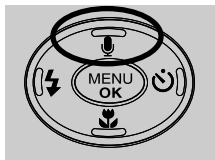

[ Preparing for Voice Memo ]



[ Recording Voice Memo ]

# Voice memo( )/ UP button

3. Press the shutter button and take a picture. The picture is stored on the memory card.
4. Voice memo will be recorded for ten seconds from the moment the picture is stored.  
In the middle of the sound recording, pressing the shutter button will stop the voice memo.

## INFORMATION

- A distance of 40cm between you and the camera (microphone) is the best distance to record sound.

# Macro( ) / Down button (Focusing)

- While the menu is showing, press the DOWN button to move from the main menu to a submenu, or to move down the submenu cursor.
- When the menu is not showing, you can use the MACRO (  )/DOWN button to take macro pictures (within the distance range of 5-80 cm for WIDE and 50-80 cm for TELE) in the STILL IMAGE mode.

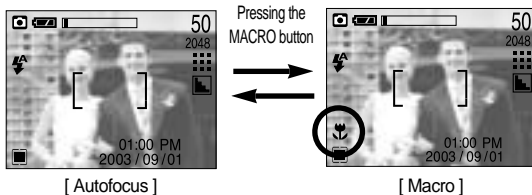
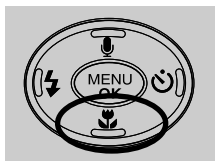

## INFORMATION

- Auto : The changed Focus mode will be maintained until the camera is turned off.  
Manual : The changed Focus mode will be maintained even after the camera is turned off.  
Night : The MACRO button will not work.
- When the macro mode is selected, it is possible that camera shake will occur.  
If this is the case, use a tripod to eliminate this.
- When the macro mode is selected, it is recommended that you use the LCD monitor to compose these shots.

# Focus lock

■ To focus on the subject positioned outside of the center, use the focus lock function.

## ● Using the Focus Lock

1. Ensure the subject in the center of the autofocus frame.
2. Press the SHUTTER button halfway. The camera status lamp (green) will light up, indicating that the camera is in focus. Be careful not to press the SHUTTER button all the way down to avoid taking an unwanted picture.
3. With the SHUTTER button still pressed down only halfway, move the camera to recompose your picture as desired, and then press the SHUTTER button completely to take the picture. If you release your finger from the SHUTTER button, the focus lock function will be canceled.

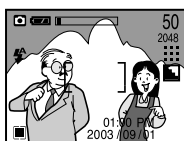

[ The image to be captured ]

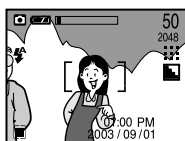

[ Press the SHUTTER button halfway and focus on the subject ]

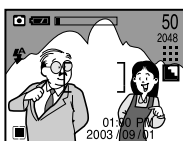

[ Recompose the picture and fully depress the SHUTTER button ]

## FLASH(⚡) / LEFT button

- When the menu is displayed on the LCD monitor, pressing the LEFT(◀) button makes the cursor shift to the left tab.
- When the menu is not displayed on the LCD monitor, the LEFT(◀) button operates as the FLASH (⚡) button.

### ● Selecting the flash mode

1. Slide the mode switch to the STILL IMAGE mode.
2. Press the Flash(⚡) button until the desired flash mode indicator displays on the LCD monitor.
3. A flash mode indicator will be displayed on the LCD monitor. Use the correct flash to suit the environment.



[ Selecting the Auto flash ]







### ● Flash range

(Unit : m)

ISO	AUTO FOCUS		MACRO	
	WIDE	TELE	WIDE	TELE
AUTO	0.8~3	0.8~2	0.2~0.8	0.5~0.8

# FLASH(⚡) / LEFT button

- Flash mode indicator

ICON	Flash mode	Description
	Auto flash	If the subject or background is dark, the camera flash will operate automatically.
	Red eye reduction	If a subject or background is dark, the camera flash will work automatically and will reduce the red-eye effect by using the red-eye reduction function.
	Fill in flash	The flash fires regardless of available light. The intensity of the flash will be controlled, according to the prevailing conditions. The brighter the background or subject is, the less intense the flash will be.
	Slow synchro	The flash will operate in conjunction with a slow shutter speed in order to obtain the correct exposure. We recommend using a tripod for this function. When you take an image in a condition with poor light, the camera shake warning indicator (  ) will display on the LCD monitor.
	Flash off	The flash does not fire. Select this mode when capturing images in a place or situation where flash photography is prohibited. When you capture an image in a poorly lit condition, the camera shake warning indicator (  ) will display on the LCD monitor.

## INFORMATION

- Using the flash frequently will reduce the life of the batteries.
- Under normal operating conditions the charging time for the flash is normally within 6 seconds. If the batteries are weak, the charging time will be longer.
- During the movie clip mode, the flash function will not operate.
- Take photographs within the flash range.
- The image quality is not guaranteed if the subject is too close or highly reflective.
- The LCD monitor is turned off for a while after using the flash to recharge it.

# Self-timer(☺) / Right(▶) button

- When the menu is displayed on the LCD monitor, pressing the Right button makes the cursor shift to the sub tab.
- When the menu is not displayed on the LCD monitor, the RIGHT button operates as the Self-timer(☺) button. This function is used when the photographer would also like to be in the image.

## ● Selecting the self-timer

1. Slide the mode switch to the STILL IMAGE mode.
2. Press the SELF-TIMER(☺) button until the desired mode indicator displays on the LCD monitor. A 2 second self-timer or 10 second self-timer icon appears on the LCD monitor.
  - 2SEC self-timer(☺<sup>2S</sup>)  
: Pressing the shutter button will allow an interval of 2 seconds before the image is taken.
  - 10SEC self-timer(☺)
3. Press the SHUTTER button. The picture will be taken after the specified time has elapsed.

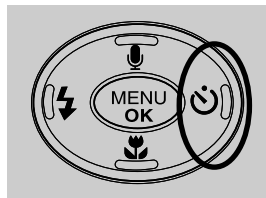

[ Selecting the 10SEC self-timer ]

## INFORMATION

- The default is OFF.
- When taking a picture using the self-timer, the function lamp works as follows:
  - 2 second self-timer setting : The function lamp blinks at 0.25 second interval for 2 seconds.
  - 10 second self-timer setting : The function lamp blinks at 1 second interval for the first 7 seconds. It blinks at 0.25 second interval for the remaining 3 seconds.
- If you operate the Power button, Mode switch, and Self-timer button during the self-timer operation, the self-timer function is cancelled.
- Use a tripod to prevent the camera from shaking.

# MENU/ OK button

- If the menu is displayed, use the 5-Function buttons (▲/▼/◀/▶) to change the data values and for your changes to be accepted.
- If the menu is not displayed, press the MENU/OK button to display a menu for the current camera mode on the LCD monitor. Press the button again to return to the previous state.

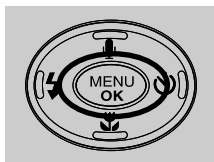

[ Menu off ]

Pressing the  
MENU  
button



[ Menu on ]

## +/- button

- You can use the +/- button to adjust the values for the exposure compensation, white balance, and ISO.

Main menu	Sub menu	Available camera mode
Exposure	-2.0EV ~ +2.0EV(0.5EV steps)	
White balance	AWB	
ISO		

- Exposure compensation
  - : This camera automatically adjusts the exposure according to the ambient lighting conditions. In Auto or Myset mode, the exposure compensation can be adjusted between -2.0EV and +2.0EV (at 0.5EV increment), and in Night mode, you can set the long time shutter. The setting value you have adjusted in Manual mode will remain unchanged even after the camera is turned off.
- Compensating Exposure
  1. Press the +/- button, and then use the UP and DOWN buttons to select the exposure compensation icon ( ). The exposure compensation menubar will appear as shown.

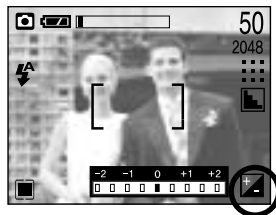

# +/- button

2. Use the LEFT and RIGHT buttons to set the desired exposure compensation factor (  $\Delta$ Ev).
3. Press the +/- button again. The value you set will be saved and the Exposure Compensation setup mode will close. If you change the exposure value, the exposure indicator (  ) will be displayed on the bottom of the LCD monitor.

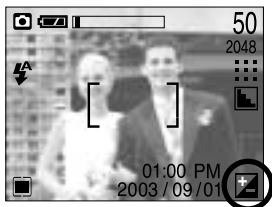

## INFORMATION

- A negative exposure compensation value reduces the exposure. Note that a positive exposure compensation value increases the exposure and the LCD monitor will appear white or you may not get good pictures.





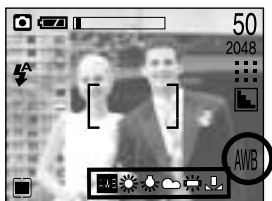

### ■ White balance

: The white balance control allows you to adjust the colours to appear more natural looking. The White Balance is available in Auto Shooting mode (  ), Manual mode, and Movie Clip mode.

### ● Selecting a White Balance

1. Press the +/- button, and then use the UP and DOWN buttons to select the white balance icon (  ). The white balance menu bar will appear as shown.
2. Use the LEFT and RIGHT buttons to set the white balance to the desired value. The value you set will be displayed on the LCD monitor.



- AUTO  : The camera automatically selects the appropriate white balance settings, depending on the prevailing lighting conditions.
- DAYLIGHT  : For taking images outside.
- CLOUDY  : For taking images under a cloudy and overcast sky.
- FLUOR.  : For shooting under fluorescent lighting.
- TUNGSTEN  : For shooting under tungsten (standard light bulb) lighting.
- CUSTOM  : Allows the user to set the white balance according to the shooting condition.

Different lighting conditions may cause a colour cast on your images.

3. Press the +/- button again. The value you set will be saved and White Balance setup mode will end.



# +/- button

## ● Using the Custom White Balance

White balance settings may vary slightly depending on the shooting environment. You can select the most appropriate white balance setting for a given shooting environment by setting up the custom white balance.

1. Select the CUSTOM (  ) menu of the White Balance.
2. Place a sheet of white paper in front of the camera so that the LCD monitor's auto focus frame ( [ ] ) shows only white, and then press the SHUTTER button.
3. Your custom white balance value will be stored.
4. Press the +/- button. The white balance menu bar will disappear.
  - The custom white balance value will be applied to the next picture you take and thereafter.
  - The custom white balance value will not change until you set it again to another value.

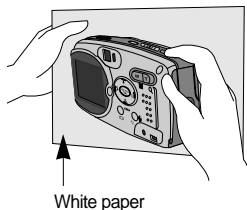

- ISO: You can select the ISO sensitivity when taking pictures. The speed or specific light-sensitivity of a camera is rated by ISO numbers. This is available only in Auto or Manual mode.

## ● Selecting an ISO Sensitivity

1. Press the +/- button, and then use the UP button to select the ISO icon(  ). The ISO menu bar will appear as shown.
2. Use the LEFT and RIGHT buttons to select the desired ISO sensitivity value.

- AUTO : The camera's sensitivity is automatically changed by variables such as lighting value or subject brightness.
- 100, 200, 400 : You can increase the shutter speed while the same amount of light is present, by increasing the ISO sensitivity. However, the image may be saturated in high luminance.

The higher the ISO value, the higher the camera's sensitivity to light is and therefore the greater its capacity to take pictures in dark conditions. However, the noise level in the image will increase as the ISO value increases, making the image appear coarse.

3. When you press the +/- button again, the value you set will be saved and ISO setup mode will end.

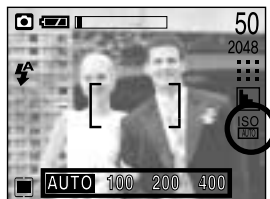

# +/- button

## ■ Userset mode

: This camera automatically adjusts the shutter speed and aperture values to the shooting environment. However, in Night Shot mode, you can set the shutter speed and aperture values to your preference. Select Night Shot mode, and then press the +/- button.

The zoom function does not work while setting up the aperture value and shutter speed.

### 1) Selecting the Night Shot Mode

1. Slide the MODE switch to select Still Image mode (  ).
2. Press the MENU button.
3. Use the LEFT and RIGHT buttons to select the [MODE] menu tab, and then use the UP and DOWN buttons to select the [NIGHT] menu.
4. Press the MENU button. The menu will disappear and the mode will switch to Night Shot mode.

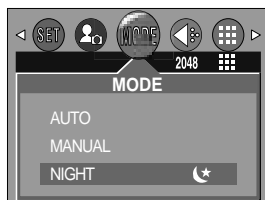

### 2) Setting Userset mode

1. In Night Shot mode, press the +/- button. A screen appears as shown to the right.
2. Use the LEFT and RIGHT buttons to set the shutter speed. Available shutter speeds are as follows:  
AUTO, 1/8, 3/16, 1/4, 3/8, 1/2, 3/4, 1, 3/2, 2, 3, 4, 6, 8, 12, and 16 seconds.
- Use the UP and DOWN buttons to set the aperture value.  
Use the UP and DOWN button to display the large/small aperture values at the top left of the shutter speed bar.
3. Press the +/- button again. The value you set will be saved and the mode will switch to Night Shot mode. Press the SHUTTER button to take the picture.



# +/- button

- Aperture values that can be selected for each zoom position are as follows:

Optical Zoom									
Zoom Position	zoom0	zoom1	zoom2	zoom3	zoom4	zoom5	zoom6	zoom7	
Focusing range(mm)	5.8	7.4	9.1	10.7	12.4	14.0	15.7	17.4	
Aperture Value	Large	2.8	3.1	3.4	3.7	4.0	4.3	4.6	4.8
	Small	5.8	6.4	7.0	7.6	8.2	8.8	9.4	10.0

Large (Press the UP button.)



# LCD button

- You can check the recording status in the LCD monitor. Pressing the LCD button in the RECORDING (STILL IMAGE, MOVIE CLIP) mode will change the display as shown below.

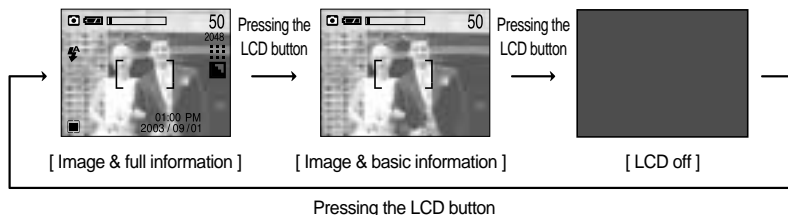
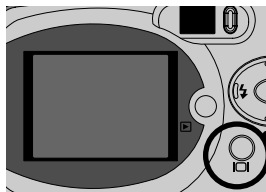

- If the LCD monitor is turned off, the camera status lamp will light up.

# Using the LCD monitor to adjust the camera settings

■ You can use the menu on the LCD monitor to set up recording functions.

















In the STILL IMAGE/ MOVIE CLIP mode, pressing the MENU button displays the menu on the LCD monitor.

## INFORMATION







- The menu will not be displayed on the LCD monitor in the following circumstances:
  - When another button is being operated.
  - While image data is being processed.  
(when the green LED next to the viewfinder blinks)
  - When there is no battery capacity.
- When the menu is showing on the LCD monitor, it is not possible to operate the shutter button i.e. capture an image. To capture an image, simply cancel the menu display by pressing the MENU button.

■ The following functions are available, depending on the mode you have selected.

The items indicated by  are default settings.

Menu tab	Main menu	Sub menu	Camera working mode
	MODE	<span style="background-color: #cccccc;">AUTO</span>	  
		MANUAL	
		NIGHT	
	SIZE	<span style="background-color: #cccccc;">2048X1536</span>	  
		2048X1360	
		1600X1200	
		1024X768	
		640X480	
		<span style="background-color: #cccccc;">320X240</span>	
		160X120	
	QUALITY	S.FINE	  
		<span style="background-color: #cccccc;">FINE</span>	
		NORMAL	
		<span style="background-color: #cccccc;">HIGH</span>	
		LOW	
	METERING	<span style="background-color: #cccccc;">MULTI</span>	 
		SPOT	

# Using the LCD monitor to adjust the camera settings

Menu tab	Main menu	Sub menu	Camera working mode
	EFFECT	NORMAL	  
		B&W	
		SUNSET	
		SEPIA	
		RGB	
	SHARP	SOFT	 
		NORMAL	
		VIVID	

## How to use the menu

1. Turn on the camera and press the MENU button. A menu for each camera mode appears. However, there is no menu for Voice Recording mode. (  )
2. Use the LEFT and RIGHT buttons to navigate through the menus.





3. Use the UP and DOWN buttons to select a sub menu.



4. Select a sub menu, and then press the OK button. The value you set will be saved and the menu will disappear.

# Mode

- You can select the desired Still Image mode.  
This is available in Auto, Manual, and Night modes.

-  **AUTO** : Use this for shooting basic still images.
-  **MANUAL** : Use this to store your custom settings for the camera. Any changes made to settings other than Self-Timer and Voice Recording will be saved.
-  **NIGHT** : Use this for shooting still images at night or in other dark conditions.



[ STILL IMAGE mode ]

## Size

- You can select the image size appropriate for your application.  
You can select from AUTO, MANUAL, NIGHT and Movie Clip modes.

Mode	STILL IMAGE mode					MOVIE CLIP mode	
Icon	2048	2048P	1600	1024	640	320	160
Size	2048 X 1536	2048 X 1360	1600 X 1200	1024 X 768	640 X 480	320 X 240	160 X 120

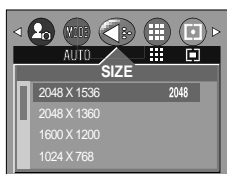

[ STILL IMAGE mode ]





[ MOVIE CLIP mode ]

## INFORMATION

- The higher the resolution, the lower the number of available shots will be because high resolution images require more memory than lower resolution images.

# Quality

- You can select the compression ratio appropriate for your application of the captured images. The higher the compression ratio, the lower the picture quality. This is available in Auto, Manual, Night, and Movie clip modes

Mode	STILL IMAGE mode			MOVIE CLIP mode	
Icon				320	160
Sub menu	S.FINE	FINE	NORMAL	HIGH	LOW
File Format	jpeg	jpeg	jpeg	mov	mov



[ STILL IMAGE mode ]



[ MOVIE CLIP mode ]

- Image Size and Quality for the Number of Images that can be saved in a Memory Card/Shooting Time(When using a 32MB Memory Stick Duo; based on Samsung's own testing)

Mode	STILL IMAGE mode					MOVIE CLIP mode	
Quality/Size	2048	2048P	1600	1024	640	320 x 240	160 x 120
S.FINE	17	19	27	66	169	-	-
FINE	33	38	54	132	336	-	-
NORMAL	50	56	82	198	501	-	-
HIGH	-	-	-	-	-	4 MIN	8 MIN
LOW	-	-	-	-	-	7 MIN	12 MIN

## INFORMATION

- S.FINE is the highest quality and NORMAL is the lowest setting. Choose the setting appropriate for your needs.
- This file format complies with the DCF(Design rule for Camera File system).
- Even if the camera should be restarted, the quality setting is maintained.
- JPEG (Joint Photographic Experts Group): JPEG is the image compression standard developed by the Joint Photographic Experts Group. This type of compression is most commonly used for compressing photos and graphics because it can compress the files efficiently without damaging the data.

# Metering

- If you cannot obtain suitable exposure conditions, you can change the metering method to take brighter pictures. This can be set in Auto and Manual modes.

**MULTI** (  ) : Exposure will be calculated based on an average of the available light in the image area. However, the calculation will be biased towards the centre of the image area. This is suitable for general use.

**SPOT** (  ) : Only the rectangular area in the center of the LCD monitor will be metered for light. This is suitable when the subject in the center is exposed correctly, regardless of the back lighting.

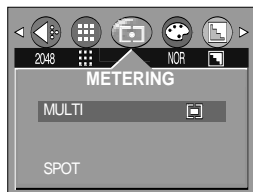

## INFORMATION

- The default metering mode is Multi pattern metering.
- If the subject is not the centre of the focus area, do not use the spot metering as this may result in an exposure error. In this circumstance, rather use exposure compensation.

## Effect

- By using the camera's digital processor, it is possible to add special effects to your images. You can select from AUTO, MANUAL, and Movie Clip modes. The value you set will remain unchanged until the camera is turned off.

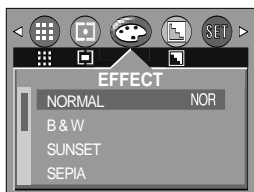

[ STILL IMAGE mode ]

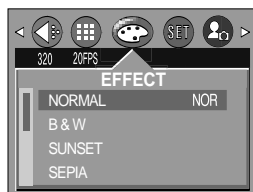

[ MOVIE CLIP mode ]

**NORMAL** : No effect is added to the image.

**B & W** : Converts the image to black and white.

**SUNSET** : Used for capturing images at sunset

**SEPIA** : Captured images will be stored in a sepia tone (a gradient of yellowish brown colours).

**RGB** : Allows the user to adjust the R (Red), G (Green), and B (Blue) values of the images to be captured.



# Effect

## ● Setting RGB Values

1. Use the DOWN button to select [RGB] among the Effect submenus, and then press the OK button. A screen that looks like the one shown on the right will appear.

2. Use the UP and DOWN buttons to select the [OFF] or [ON] auxiliary menu, and then press the OK button.

[OFF] : Select this if you do not want to change the RGB values.

[ON] : Select this to open a window where you can adjust the RGB values.

Use the UP and DOWN buttons to navigate the R, G, and B controls. Use the LEFT and RIGHT buttons to set the value for each control. If you press the OK button, your changes will be saved and the menu will disappear.

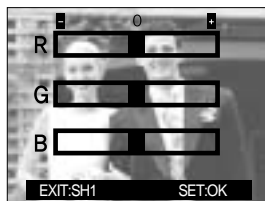
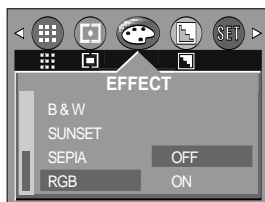

## Sharpness

■ You can adjust the sharpness of the picture you want to take.

You cannot check the sharpness effect on the LCD monitor before you take a picture, because this function is applied only when the captured image is stored on the memory. You can select from AUTO and MANUAL modes.

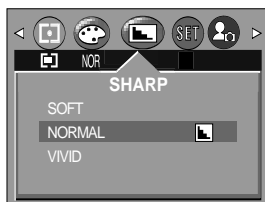

[ STILL IMAGE mode ]

Sub menu	Icon	Description
SOFT		The edges of the image are softened. This effect is suitable for editing images on your PC.
NORMAL		The edges of the image are sharp. This is suitable for printing.
VIVID		The edges of the image are emphasized. The edges will appear sharp, but noise may occur in the recorded image.

# Starting play mode

- Turn the camera on and select Play mode by pressing the play mode button (  ).  
The camera can now play back the images stored in the memory.
- If you have turned on the camera by pressing the POWER button, you can press the PLAY button once to switch to Play mode and press it again to switch to Recording mode.  
If you have turned on the camera by pressing the PLAY button, you can press the PLAY button again to turn off the camera.
- You can set up the PLAY mode function by using the camera buttons and LCD monitor.

## ● Playing back a still image

1. Select the PLAY mode(  ) by pressing the play mode button.



2. The last image stored on the memory is displayed on the LCD monitor.



3. Select an image that you want to play back by pressing the LEFT / RIGHT button.

- ※ Press and hold the LEFT or RIGHT button to play back the images quickly.

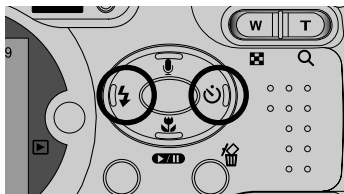

## INFORMATION

- Manner mode: Pressing the power button for more than 3 seconds changes the buzzer and start-up sound setting to OFF, even though you may have set these to ON. To turn on the startup sound and operation sound, set the startup sound (MyCAM mode) and operation sound (Setup mode) to a setting other than [OFF].
- Even if the camera's power is off, you can start the play mode by pressing the play mode button.

# Starting play mode

## ■ Playing back a movie clip

Steps from 1-2 are the same as those to play back a still image.

3. Select the recorded movie clip that you want to play back by using the LEFT/RIGHT button. If you select a movie clip, the movie clip indicator (  ) will be displayed on the LCD monitor.

4. Press the play & pause button (  ) to play back a movie clip file.

- To pause a movie clip file while playing it back, press the play & pause button again.

- Pressing the play & pause button again will cause the movie clip file will restart.

- To rewind the movie clip while it is playing, press the LEFT button. To fast forward the movie clip, press the RIGHT button.

- To stop playback of the movie clip, press the play & pause button (  ), and then press the LEFT or RIGHT button.

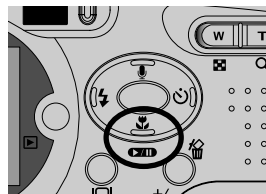
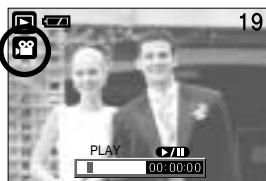

## ■ Playing back a recorded voice

Steps from 1-2 are the same as those to play back a still image.

3. Select the recorded voice that you want to play back by using the LEFT/RIGHT button. If you select a recorded voice file, the voice indicator (  ) will be displayed on the LCD monitor.

4. Press the play & pause button (  ) to play back a recorded voice file.

- To pause a recorded voice file, while playing it back, press the play & pause button again.

- To resume playback of the voice file, press the play & pause button.

- To rewind the voice file while it is playing, press the LEFT button. To fast forward the voice file, press the RIGHT button.

- To stop playback of the voice file, press the play & pause button, and then press the LEFT or RIGHT button.

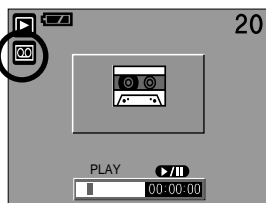

# LCD monitor indicator

■ The LCD monitor displays information about the shooting conditions.



No.	Description	Icon	Page
1	Battery		P.15
2	Play mode		
3	File Type		
4	Voice memo		P.46
5	Protect indicator		P.52
6	DPOF indicator		P.56
7	Stored image number	9	

■ If you press the LCD button, you can check the following recording information:

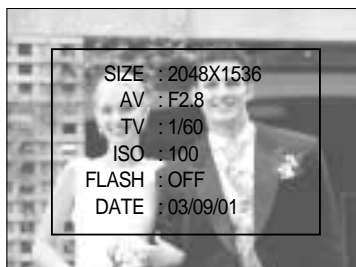

SIZE	: 2048X1536	Size
AV	: F2.8	Aperture value
TV	: 1/60	Shutter speed
ISO	: 100	ISO sensitivity
FLASH	: OFF	Whether or not the flash is used.
DATE	: 03/09/01	Recording date

# Using the camera buttons to adjust the camera



- In Play mode, you can use the buttons on the camera to conveniently set up the Play mode functions.

## Thumbnail( ) / Enlargement( ) button

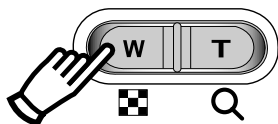
- You can view multiple pictures, enlarge a selected picture, and crop and save a selected area of an image.
- Thumbnail display
  1. While an image is displayed full screen, press the thumbnail button.
  2. The thumbnail display will highlight the image that had been showing at the time the thumbnail mode was selected.
  3. Press the 5 function button to move to a desired image.
  4. To view an image separately, press the enlargement button (  ).



[ Normal display mode ]

Pressing the thumbnail button(  )  
→  
←  
Pressing the enlargement button(  )  
→  
Highlighted image

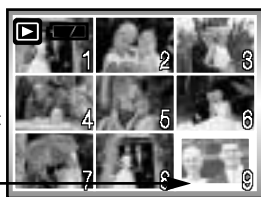

[ Thumbnail display mode ]

## ● Image enlargement

1. Select an image that you want to enlarge and press the enlargement button.
2. Different parts of the image can be viewed by pressing the 5 function button.
3. Pressing the thumbnail button will zoom back to the original full sized image.
  - You can tell whether the image displayed is an enlarged view by checking the image enlargement indicator shown at the bottom left of the LCD monitor. (If the image is not an enlarged view, the indicator will not be displayed.) You can also check the area of enlargement.
  - Movie clips and WAV files can't be enlarged.
  - If an image is enlarged, a loss of quality may occur.

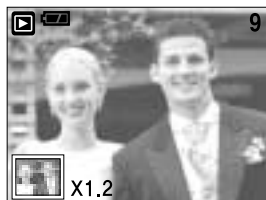
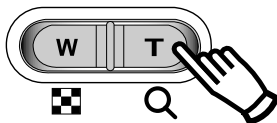

## Thumbnail( ) / Enlargement( ) button

- The maximum enlargement rate in proportion to the image size.

Image size	2048/2048P	1600/1024	640
Maximum enlargement rate	X5	X3	X1.5

- Trimming : You can extract part of the image that you want and save it separately.

1. Select an image that you want to enlarge and press the enlargement button.
2. Different parts of the image can be viewed by pressing the 5 function button.
3. Press the MENU button and a message will be displayed as shown alongside.
4. Press the OK button to save the trimmed image with a new file name. The trimmed image will be displayed on the LCD monitor. Press the LEFT button to return to the image before it was selected.
  - If there is little memory space to save the trimmed image, the image can't be trimmed.



## Voice( ) memo / Up button

- When the menu is displayed on the LCD monitor, pressing the UP button makes the menu cursor move up.
- When the menu is not displayed on the LCD monitor, the UP button operates as the voice memo button. You can add your audio to a stored still image.

- Adding a Voice Memo to a Still Image

1. Press the LEFT/ RIGHT button to select an image that you wish to add sound to.
2. Press the voice memo button (  ) and the voice memo indicator will display. The camera is now ready to record a voice memo.



# Voice( ) memo / Up button

3. Press the shutter button to start recording. The [REC] message will be displayed on the LCD monitor (as shown) and voice will be recorded to the still image for 10 seconds.



4. The recording can be stopped by pressing the shutter button again.

5. The (  ) icon will be displayed on the LCD monitor after voice memo recording has finished.

- Voice memos can't be recorded onto movie clip files.
- A distance of 40cm between you and the camera (microphone) is the best distance to record sound.
- The voice memo will be saved in \*.wav format, but has the same file name as the still image to which it corresponds.
- If you add a new voice memo to the still image that already has a voice memo, the existing voice memo will be erased.



## Play & Pause( ) / Down button

■ In Play mode, the play & pause/ down button works as follows:

- If the menu is displayed

Press the DOWN button to move from the main menu to a sub menu, or to move down the sub menu cursor.

- If a still image with a voice memo, a voice file, or a movie clip is playing

In Stop mode : Plays a still image with a voice memo, a voice file, or a movie clip.

During playback : Temporarily stops playback.

In Pause mode : Resumes playback

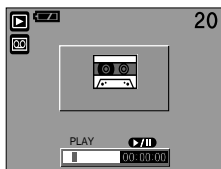

[ Voice recording is stopped ]

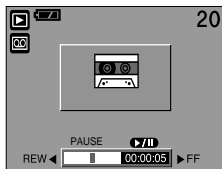

[ Voice file is playing ]

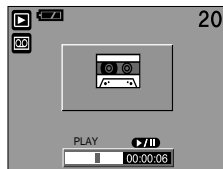

[ Voice recording is paused ]

# LEFT / RIGHT/ MENU/ OK button

■ LEFT / RIGHT/ MENU/ OK buttons activate the following.

- LEFT button : While the menu is showing, press the LEFT button to select the menu tab to the left of the cursor.
- RIGHT button : While the menu is showing, press the RIGHT button to select the menu tab to the right of the cursor, or to move an auxiliary menu.
- MENU button : When you press the MENU button, the play mode menu will be displayed on the LCD monitor. Pressing it again will return the LCD to the initial display.
- OK button : When the menu is displayed on the LCD monitor, the OK button is used for confirming data that is changed by using the 5 function button.

## LCD button

■ The shooting information will be displayed on the LCD monitor.

The last image stored in the memory is displayed on the LCD monitor by pressing the play mode button.

Pressing the LCD button in the PLAY (  ) mode will change the display as shown below. [Image & Icons] → [Image & Information] → [Image only]

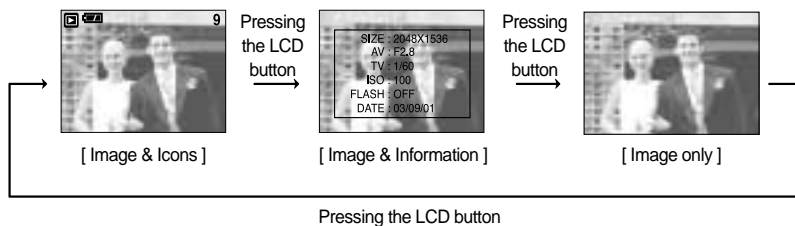
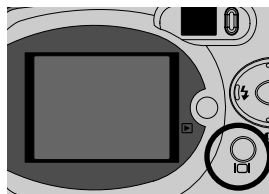

■ If you press the LCD button in Thumbnail Display mode, the image to be deleted (  ) will be selected.



# Delete( ) button

■ This deletes images stored on the memory card.

## ● Deleting Images in Play Mode

1. Select an image that you want to delete by pressing the LEFT / RIGHT button and press the DELETE(  ) button.
2. A message will display as shown alongside on the LCD monitor.
3. Press the OK button to delete the image. The image that precedes the deleted one will then be displayed on the LCD monitor.

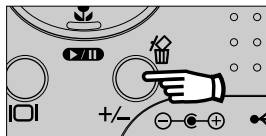

## ● Deleting Images in Thumbnail Display Mode

1. Use the UP, DOWN, LEFT, and RIGHT buttons to select the image you want to delete, and then press the DELETE (  ) button.
2. The following message will be displayed on the LCD monitor.
3. Press the OK button to delete the image. The image that precedes the deleted one will be displayed on the LCD monitor.

### - Deleting Multiple Images

You can only delete the image displayed on the LCD monitor. If you press the LCD button with an image displayed on the LCD monitor selected, the image will maintain its selected state (  mark) as shown in the following illustration. Use the UP, DOWN, LEFT, RIGHT and LCD buttons to select multiple images(i.e., press the LCD button each time you select the image you want to delete), and then press the DELETE button to delete all selected images. If you want to de-select the image, press the LCD button again. The image over which the cursor is placed will be deleted simultaneously.



Press the  
DELETE  
button.









## INFORMATION

- Before deleting images from the camera, you should protect or download images to your computer that you wish to keep.

# Setting up the play back function using the LCD monitor

- PLAY mode functions can be changed by using the LCD monitor. In the PLAY mode, pressing the MENU button displays the menu on the LCD monitor. The menus you can set up in Play mode are as follows. To capture an image after setting up the play menu, press the PLAY button.

The items indicated by  are default settings.

Menu tab	Main menu	Sub menu	Secondary menu	Page	
	DEL. ALL	<span style="background-color: #cccccc;">NO</span>	-	p. 52	
		YES	-		
	PROTECT	ONE PIC	<span style="background-color: #cccccc;">UNLOCK</span>	p. 52	
			LOCK		
		ALL PICS	<span style="background-color: #cccccc;">UNLOCK</span>		
			LOCK		
	SLIDE	<span style="background-color: #cccccc;">OFF</span> ~ 10 SEC ▶	REPEAT	ON OFF	p. 53
	RESIZE	1600X1200	-	p. 54	
		1024X768	-		
		640X480	-		
		LOGO	-		
	ROTATE	<span style="background-color: #cccccc;">OFF</span>		p. 55	
		ON			
	STANDARD	<span style="background-color: #cccccc;">ONE PIC</span>	0 ~ 30 PRINTS	p. 56	
		ALL PICS			
	INDEX	<span style="background-color: #cccccc;">NO</span>	-	p. 56	
		YES			
	SIZE	<span style="background-color: #cccccc;">DEFAULT</span>	-	p. 57	
		3X5	-		
		4X6	-		
		5X7	-		
		8X10	-		
	CANCEL	<span style="background-color: #cccccc;">STANDARD</span>	-	p. 57	
		INDEX	-		
		SIZE	-		

# Setting up the play back function using the LCD monitor

Menu tab	Main menu		Sub menu	Secondary menu	Page	
	P I C T  B R I D G E	IMAGES	ONE PIC	-	p. 59	
			ALL PICS	-		
		SETUP	C U S T O M	DEFAULT	-	p. 60
				SIZE	POSTCARD	
					4X6, 8X10	
					A6, A4, B5	
				LAYOUT	FULL	
					1, 2, 4, 6, 8	
					INDEX	
				PAPER	PLAIN	
					PHOTO	
					FASTPHO.	
				QUALITY	DRAFT	
					NORMAL	
					FINE	
				DATE	ON	
					OFF	
		FILENAME	ON			
			OFF			
		PRINT			-	p. 58
		DPOF PRN			-	p. 58
RESET	NO	-	p. 58			
	YES	-				

※ Menus are subject to change without prior notice.

# Deleting all images

■ Of all the files stored in the memory card, the unprotected files in the DCIM subfolder will be deleted. (The files that were stored in the AVATAR folder will not be deleted.)

## ● Deleting all images

1. Press the play mode button and press the menu button.
2. Press the LEFT/ RIGHT button and select the [DEL.ALL] menu tab.
3. Select a desired sub menu by pressing the UP/ DOWN button and press the OK button.

Selecting [NO] : The display returns to the initial menu.

Selecting [YES] : A delete confirmation window will appear. When you press the OK button, a [PLEASE WAIT!] message will display while all the unprotected images are deleted. If there aren't protected images, all the images are deleted and a [NO IMAGE!] message will display. Press the PLAY button or slide the Mode switch to clear the message.



## INFORMATION

- Remember that this will permanently delete unprotected images. Important shots should be stored on a computer before deletion takes place.
- The startup image is stored in the camera's internal memory (i.e., not on the memory card) and it will not be deleted even if you delete all files on the memory card.

## Protecting images

■ This is used to protect specific shots from being accidentally erased (LOCK).

It also unprotects images that have been previously protected (UNLOCK).

## ● Protecting Images

1. Press the play mode button and press the menu button.
2. Press the LEFT/ RIGHT button and select the [PROTECT] menu tab.
3. Select a desired sub menu by pressing the UP/ DOWN button and press the OK button.

[ONE PIC] : Only an image that is displayed on the LCD monitor is protected or unprotected.

[ALL PICS] : All of the stored images are protected or unprotected.



# Protecting images

4. Select the desired secondary menu by pressing the UP/DOWN button and press the OK button.

[UNLOCK] : Cancels the protect function.

[LOCK] : Sets up the protect function.

- If you select the [ONE PIC] sub menu at step 3, you can protect or unprotect another image by pressing the LEFT/ RIGHT button. If you press the SHUTTER button, the Image Protection menu will disappear.

- If you selected [ALL] in Step 3, the Image Protection menu will disappear.

- If you protect an image, the protect icon(  ) will be displayed on the LCD monitor. (An unprotected image has no indicator)

- An image in LOCK mode will be protected from [DELETE] or [DELETE ALL] functions, but will NOT be protected from the [FORMAT] function.



## Starting the slide show

- Images can be displayed continuously at pre-set intervals. You can view the slide show by connecting the camera to an external monitor.

1. Press the play mode button and press the menu button.

2. Press the LEFT/ RIGHT button and select the [SLIDE] menu tab.

3. Use the UP and DOWN buttons to select the desired submenu value, and then press the RIGHT button.

- Slide Show Display Interval: OFF, 1 ~10 seconds

4. Use the UP and DOWN buttons to set whether to repeat the slide show.

[ON] : Even once a cycle(from the first image to the last image) is completed, the slide show will continue to repeat itself.

[OFF]: If a cycle is completed, the slide show will stop automatically.

5. Press the OK button and the slide show will start.

- To pause the slide show, press the play & pause button.

- To start the slide show again, press the play & pause button again.

- Press the menu button again and the slide show will stop.



## INFORMATION

- The loading time depends on the image size and quality.
- The slide show will start from an image that was displayed on the LCD monitor. The [POWER OFF] function can't be activated.
- While the slide show is playing, only the first frame of an MOVIE file is displayed. In case of a voice file, the voice recording icon will appear.

# Resize

- A stored image size can be changed and used as a logo image.

The resized image will have a new file name.

1. Press the play mode button and press the menu button.
2. Press the LEFT/ RIGHT button and select the [RESIZE] menu tab.
3. Select a desired sub menu by pressing the UP/ DOWN button and press the OK button.



## ● Image Resize Types

Sub menu	1600X1200	1024X768	640X480	LOGO
Application	For printing	For wallpaper	For simple storage	For the startup image

## INFORMATION

- A Large image can be resized to be made smaller, but a small image cannot be resized to become larger.
- Only JPG images can be resized. MOVIE and WAV files can't be resized.
- You can change the resolution of only those files compressed in the JPEG 4:2:2 format.
- The resized image will have a new file name.  
The start-up image is stored not on the memory card but on the internal memory.
- Only one startup image can be saved. If you save a new startup image, the existing startup image will be deleted.
- If the memory capacity is insufficient to store the resized image, a [CARD FULL!] message will display on the LCD monitor and the resized image will not be stored.

# Rotating an image

- You can rotate the stored images by 90, 180, or 270 degrees.

1. Press the play mode button and press the menu button.
2. Press the LEFT/ RIGHT button and select the [ROTATE] menu tab.
3. Select a desired sub menu by pressing the UP/ DOWN button.

If [OFF] is selected : Press the OK button to cancel the image rotation.

If [ON] is selected : If you press the OK button, an auxiliary menu from which you can select a rotation orientation will appear. Use the UP and DOWN buttons to select the degree of rotation. The image will be rotated according to the value you selected and be displayed on the LCD monitor.

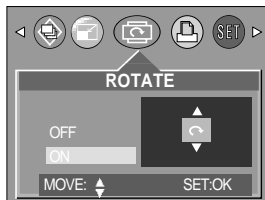

: Rotate 0°



: Rotate 90°



: Rotate 180°



: Rotate 270°

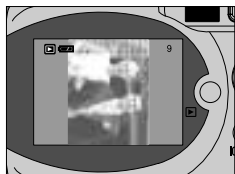

[ Rotated 90 degrees ]



[ Rotated 180 degrees ]

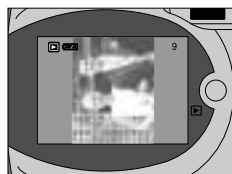

[ Rotated 270 degrees ]

4. Press the OK button. The rotated image will be saved with a new file name and the menu will disappear.

## INFORMATION

- If you display the rotated image on the LCD monitor, empty spaces may appear to the left and right of the image.

## DPOF : PRINT ORDER

- DPOF stands for Digital Print Order Format. It allows you to save the picture printing information in the DCIM/MISC folder on the memory card. You can select the picture you want to print using this information and specify the number of copies to print.
- The DPOF indicator will display on the LCD monitor when an image that has DPOF information plays back. Images can then be printed on DPOF printers, or at an increasing number of photo labs.
- This function is not available for Movie clips and WAV files.

# DPOF : STANDARD

■ This function allows you to embed print quantity information on a stored image.

1. Press the play mode button and press the menu button.
2. Press the LEFT/ RIGHT button and select the [DPOF] menu tab.
3. Select the [STANDARD] menu by pressing the UP/ DOWN button and press the RIGHT button.
4. Use the UP and DOWN buttons to select [ONE PIC] or [ALL PICS], and then press the OK button. A window for selecting number of copies.

[ONE PIC] : Set the number of copies to print for the current picture only.

[ALL PICS] : Set the number of copies to print for each picture, excluding movie clips and voice recordings.

5. Use the UP and DOWN buttons to select the number of copies and then press the OK button.

- If you selected [ONE PIC] in Step 4, you can use the

LEFT and RIGHT buttons to set the number of copies to print for the previous or the next picture. Press the SHUTTER button. The Number of Copies setup menu will disappear.

- If you selected [ALL] in Step 4, the Number of Copies setup menu will disappear.

- The DPOF icon (  ) will appear by the pictures for which the number of copies to print is set.

6. Press the MENU button twice and the menu will disappear.



## DPOF : INDEX

■ Images (except for movie clips and voice file) are printed as index type.

1. Press the play mode button and press the menu button.
2. Press the LEFT/ RIGHT button and select the [DPOF] menu tab.
3. Select the [INDEX] menu by pressing the UP/ DOWN button and press the RIGHT button.
4. Select a desired sub menu by pressing the UP/ DOWN button.

If [NO] is selected : The image will be printed in standard print format.

If [YES] is selected : The image will be printed in index format.

5. Press the OK button to confirm the setting.
6. Press the menu button twice and the menu will disappear.





# DPOF : PRINT SIZE

- You can specify the print size when printing images stored on the memory card. The print size you set will be applied to all pictures stored on the memory card.

## ● Setting the Print Size

1. Press the play mode button and press the menu button.
2. Press the LEFT/ RIGHT button and select the [DPOF] menu tab.
3. Select the [SIZE] menu by pressing the UP/ DOWN button and press the RIGHT button.
4. Select a desired sub menu by pressing the UP/ DOWN button.

SIZE: DEFAULT, 3X5, 4X6, 5X7, 8X10

5. Press the OK button to confirm the setting.
6. Press the menu button twice and the menu will disappear.

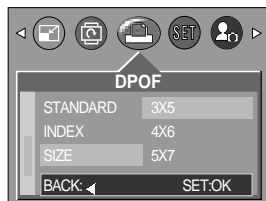

- \* The [DEFAULT] print size varies depending on the printer manufacturer.

For your printer's default value, please refer to the user's guide that came with your printer.

# DPOF : CANCEL

- You can cancel the [STANDARD], [INDEX], or [SIZE] settings. Cancel the setting to reset the value to its default.

1. Press the play mode button and press the menu button.
2. Press the LEFT/ RIGHT button and select the [DPOF] menu tab.
3. Select the [CANCEL] menu by pressing the UP/ DOWN button and press the RIGHT button.
4. Select a desired sub menu by pressing the UP/ DOWN button.

If [STANDARD] is selected : Cancels the standard print setting.

If [INDEX] is selected : Cancels the index print setting.

If [SIZE] is selected : Cancels the print size setting.

5. Press the OK button to confirm the setting.
6. Press the menu button twice and the menu will disappear.

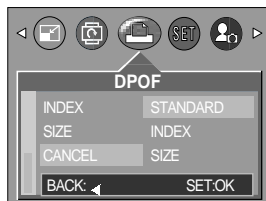

# PictBridge

- You can use the USB cable to connect this camera to a printer that supports PictBridge (sold separately) and print the stored images directly. Movie clips and voice files cannot be printed. You can set up the following settings from the PictBridge menu.

IMAGES	: Setting up the scope of PictBridge
PRINTER SETUP	: Setting up printing
PRINT	: Printing pictures
DPOF AUTO PRINT	: Printing the DPOF files
RESET	: Initializing the PictBridge functions

## ● Connecting the Camera to a Printer

1. Press the POWER button to turn on the camera.
2. In a mode other than Voice Recording mode, press the MENU button.
3. Press the LEFT/ RIGHT button and select [SETUP] menu tab.
4. Select [USB] menu by pressing the UP/ DOWN button and press the RIGHT button.
5. Select [PRINTER] menu by pressing the UP/ DOWN button and press the OK button.
6. Press the menu button twice and the menu will disappear.
7. Use the supplied USB cable to connect the camera to the printer as shown below.

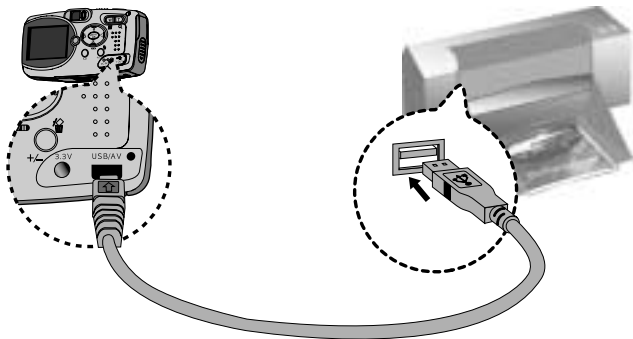

8. Turn on the printer to connect the camera to the printer.

- ※ If you selected [Computer] in Step 5, when you connect the camera to your printer, the camera status lamp (red) will blink and the connection will not be established. In this case, disconnect the USB cable, and then follow the procedure from Step 2 and onward.

# PictBridge: Picture Selection

■ You can select the scope of the PictBridge function.

1. Connect the camera to your printer. The USB menu must be set to [PRINTER] before you connect the camera to the printer. (See p.58)
2. The [PICTBRIDGE] menu will appear.
3. Use the UP and DOWN buttons to select [IMAGES], and then press the RIGHT button.
4. Use the UP and DOWN buttons to select the desired submenu value, and then press the OK button.

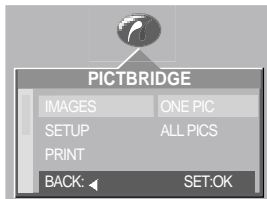

When [ONE PIC] is selected : The PictBridge function will be applied only to the picture currently displayed.

When [ALL PICS] is selected : The PictBridge function will be applied to all pictures, excluding movie clips and voice files.

● Setting the Number of Copies to Print

- Select [ONE PIC] or [ALL PICS]. A screen where you can set the number of copies to print will appear as shown below.



[ When [ONE PIC] is selected ]

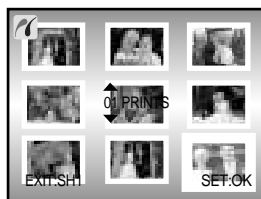

[ When [ALL PICS] is selected ]

- Use the UP and DOWN buttons to select the number of copies to print and then press the OK button. The number of copies you wish to make: 30  
Unless you press the OK button, the changed number of prints will not be applied.
- When selecting [ONE PIC] in Step 4, you can use the LEFT and RIGHT buttons to move to the previous or next picture.
- Press the SHUTTER button to return to the PictBridge menu.

# PictBridge: Print Setting

■ You can select the Paper Size, Print Format, Paper Type, Print Quality, Date Print, and File Name Print menus for printed pictures.

1. Connect the camera to your printer. The USB menu must be set to [PRINTER] before you connect the camera to the printer. (See p.58)
2. The [PICTBRIDGE] menu will appear.
3. Use the UP and DOWN buttons to select [PRINTER SETUP], and then press the RIGHT button.
4. Use the UP and DOWN buttons to select the desired submenu value, and then press the OK button.

If [DEFAULT] is selected

: The print format will be set to the printer's default values.

If [CUSTOM] is selected

: A window from which the user can set up the print format with the desired values will appear.

Use the UP and DOWN buttons to select a submenu value, and then press the RIGHT button.

Auxiliary menus will appear. Use the UP and DOWN buttons to select the desired auxiliary menu, and then press the OK button.

The menus you can set up are as follows:

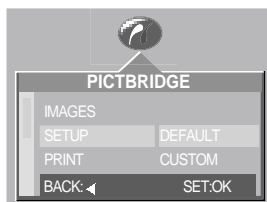

Menu	Function	Sub menu
SIZE	Setting the size of the printing paper	POSTCARD, 4X6, 8X10, A6, A4, B5
LAYOUT	Setting the number of pictures to be printed on a sheet of paper	FULL, 1, 2, 4, 6, 8, INDEX
PAPER	Setting the quality of the printing paper	PLAIN, PHOTO, FASTPHOTO
QUALITY	Setting the quality of the picture to be printed	DRAFT, NORMAL, FINE
DATE	Setting whether to print the date	ON, OFF
FILENAME	Setting whether to print the file name	ON, OFF

※ Depending on the manufacturer and model of your printer, some menus are inaccessible. Even though these menus will still appear on the LCD monitor, but you will not be able to select them.

# PictBridge: Picture Printing

## ■ Printing Pictures

1. Connect the camera to your printer. The USB menu must be set to [PRINTER] before you connect the camera to the printer. (See p.58)
2. The [PICTBRIDGE] menu will appear.
3. Use the UP and DOWN buttons to select the [PRINT] menu, and then press the OK button.

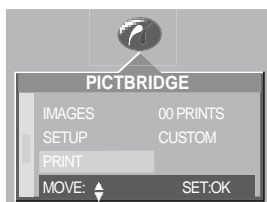

4. The screen shown on the right will appear and the picture will be printed. If no picture is selected, the [NO IMAGE!] message will be displayed. If you press the SHUTTER button during printing, printing will be cancel and the menu from Step 2 will appear.

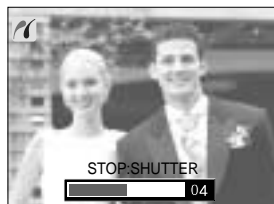

5. If an error occurs during printing, the screen shown below will appear.



[ Fatal error ]

Press the OK button to cancel printing.  
Follow the Steps 1 to 4 again to print the picture(s).

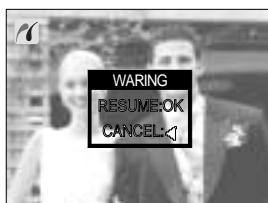

[ Recoverable error ]

Press the OK button to resume printing, or press the RIGHT button to cancel printing.

## INFORMATION

- When printing pictures by connecting the camera to the printer, use the AC adapter.
- If the printer is turned off during printing, the printing will stop and the paper will be dispelled.
- If there are continuous print error, please check the print condition.

# PictBridge : DPOF AUTO PRINT

- This allows you to directly print the files with DPOF information.  
For instructions on how to set up DPOF, refer to pages 55 to 57.

1. Connect the camera to your printer. The USB menu must be set to [PRINTER] before you connect the camera to the printer.(See p.58)
2. The [PICTBRIDGE] menu will appear.
3. Use the UP and DOWN buttons to select the [DPOF PRINT] menu, and then press the OK button.

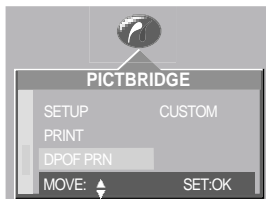

4. The screen shown on the right will appear and the picture will be printed. If no picture is selected, the [NO IMAGE!] message will be displayed. If you press the SHUTTER button during printing, printing will be cancel and the menu from Step 2 will appear.

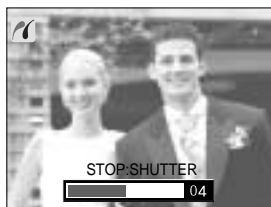

5. If an error occurs during printing, the error message number 5 on page 61 will be displayed.  
For details, please refer to page 61.

## PictBridge : RESET

- This allows you to restore the values of the PictBridge menu, which was changed in CUSTOMIZE, to their default values.

1. Connect the camera to your printer. The USB menu must be set to [PRINTER] before you connect the camera to the printer.(See p.58)
2. The [PICTBRIDGE] menu will appear.
3. Select the [RESET] menu by pressing the UP/ DOWN button and press the RIGHT button.
4. Select a desired sub menu by pressing the UP/ DOWN button and press the OK button.

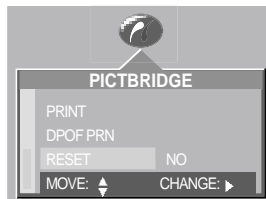

- If [NO] is selected : Settings will not be reset.
- If [YES] is selected : All print and image settings will be reset.

- ※ Default print setting varies depending on the printer manufacturer.  
For your printer's default setting, refer to the user's guide that came with your printer.



# Setup menu

■ In this mode, you can set up basic settings. You can use the setup menu in all camera modes, except Voice Recording mode. The changed setup mode values will be maintained even if you turn the camera off and then back on.

The items indicated by   are default settings.

Menu tab	Main menu	Sub menu	Secondary menu	Page
	FILE	RESET		p.65
		SERIES		
	POWER OFF	CANCEL		p.65
		ON	▲ 01 - <span style="background-color: #cccccc;">03</span> ~10 MIN ▼	
	LANGUAGE	KOREAN	JAPANESE	p.66
		ENGLISH	RUSSIAN	
		FRENCH	PORTUGUESE	
		GERMAN	DUTCH	
		SPANISH	DANISH	
		ITALIAN	SWEDISH	
		S.CHINESE	FINNISH	
		T.CHINESE	THAI	
	FORMAT	NO		p.66
		YES		
	DATE	▲ <span style="background-color: #cccccc;">03</span> /01/01 13:00 ▼		p.67
		Y/M/D		
		M/D/Y		
		D/M/Y		
	IMPRINT	OFF		p.67
		DATE		
		D & TIME		
	LAMP	OFF		p.68
		ON		

# Setup menu

Menu tab	Main menu	Sub menu	Secondary menu		Page	
	SOUND	OFF			p.69	
		LOW				
		MEDIUM				
		HIGH				
	LCD	LCD	DARK			p.69
			NORMAL			
			BRIGHT			
	VIDEO	VIDEO	NTSC			p.70
			PAL			
	Q.VIEW	Q.VIEW	OFF			p.71
			 1 ~ 5 SEC 	DEL.ANS.	ON	
	USB	USB	COMPUTER			p.72
			PRINTER			
	RESET	RESET	NO			p.72
YES						

## File name

■ This function allows the user to select the file naming format.

### ● Assigning File Names

- In any mode other than Voice Recording mode, press the MENU button.
- Press the LEFT/ RIGHT button and select the [SETUP] menu tab.
- Select the [FILE] menu by pressing the UP/ DOWN button and press the RIGHT button.
- Select a desired sub menu by pressing the UP/ DOWN button and press the OK button.

[RESET] : After using the reset function, the next file name will be set from 0001 even after formatting, deleting all or inserting a new memory card.

[SERIES] : Under this system, the file name will directly follow the last stored file name, regardless of any actions such as file deletion or formatting.

- Press the menu button twice and the menu will disappear.





# File name

## INFORMATION

- The first stored folder name is 100SSCAM, and the first file name is SUC30001.
- Whenever you store an image, the file number is increased by 1.
- The file numbers are named from SUC30001 to SUC39999 automatically, 9999 files will be stored in a folder.
- The folder number is assigned sequentially from 100 to 999 as follows: 100SSCAM → 101SSCAM → ~ → 999SSCAM.
- The files used with the memory card conform to the DCF(Design rule for Camera File systems) format.

## Auto power off

- This function switches the camera off after a set amount of time in order to prevent unnecessary battery drainage.

### ● Setting Power Off

1. In any mode other than Voice Recording mode, press the MENU button.
2. Press the LEFT/ RIGHT button and select the [SETUP] menu tab.
3. Select the [PWR OFF] menu by pressing the UP/ DOWN button and press the RIGHT button.
4. Select a desired sub menu by pressing the UP/ DOWN button and press the OK button.

Selecting [CANCEL] : The power off function will not operate.

Selecting [ON] : A menu will be displayed on the LCD monitor as shown alongside. Select the desired time by pressing the UP/DOWN button.

5. Press the menu button twice and the menu will disappear.

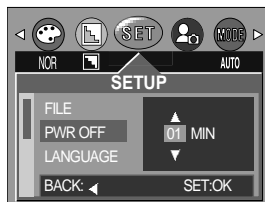

## INFORMATION

- Even if the batteries or AC adapter are removed and inserted again, the power off setting will be preserved.
- Note that the automatic power off function will not operate if the camera is in PC mode, slide show, playing back a voice recording or movie clip.

# Language

- There is a choice of languages that can be displayed on the LCD monitor. Even if the batteries or AC adapter are removed and inserted again, the language setting will be preserved.

## ● Setting Language

1. In any mode other than Voice Recording mode, press the MENU button.
2. Press the LEFT/ RIGHT button and select the [SETUP] menu tab.
3. Select the [LANGUAGE] menu by pressing the UP/ DOWN button and press the RIGHT button.
4. Select a desired sub menu by pressing the UP/ DOWN button and press the OK button.

LANGUAGE sub menu

: Korean, English, French, German, Spanish, Italian,

T.Chinese, S.Chinese, Japanese, Russian, Portuguese, Dutch, Danish, Swedish, Finnish, Thai.

5. Press the menu button twice and the menu will disappear.



## Formatting a memory card

- This is used for formatting the memory card. If you run [FORMAT] on the memory card, all images, including the protected images, will be deleted. Be sure to download important images to your PC before formatting the memory card.

## ● Formatting a Memory Card

1. In any mode other than Voice Recording mode, press the MENU button.
2. Press the LEFT/ RIGHT button and select the [SETUP] menu tab.
3. Select the [FORMAT] menu by pressing the UP/ DOWN button and press the RIGHT button.
4. Select a desired sub menu by pressing the UP/ DOWN button and press the OK button.

If [No] is selected : The memory card will not be formatted. Press the menu button twice and the menu display will disappear.

If [Yes] is selected : A [PLEASE WAIT!] message appears and the memory card will be formatted. If you ran FORMAT in Play mode, a [NO IMAGE!] message will appear.



## INFORMATION

- Be sure to run [FORMAT] on the following types of memory card.
  - A new memory card, or an unformatted memory card.
  - A memory card that has a file this camera can't recognize or one that has been taken from another camera.
- Always format the memory card using this camera. If you insert a memory card that has been formatted using other cameras, memory card readers, or PCs, you will get a [CARD ERROR!] message.

# Setting up the Date/ Time/ Date type

- You can change the date and time that will be displayed on the captured images and set up the date type.

- Setting Date/Time & Selecting Date type

1. In any mode other than Voice Recording mode, press the MENU button.
2. Press the LEFT/ RIGHT button and select the [SETUP] menu tab.
3. Select the [DATE] menu by pressing the UP/ DOWN button and press the RIGHT button.
4. Use the UP, DOWN, LEFT, and RIGHT buttons to select the desired submenu value, and then press the OK button.

RIGHT button : Selects the

year/month/day/hour/minute/date type.

LEFT button : Moves the cursor to the [DATE/TIME] main menu if the cursor is at the first item of the date and time setup. In all other cases, the cursor will be shifted to the left of its current position.

UP and DOWN buttons: Changes the setting value.

- Date type

[YY/MM/DD] : year/month/day

[MM/DD/YY] : month/day/year

[DD/MM/YY] : day/month/year

5. Press the menu button twice and the menu will disappear.



## Imprinting the recording date

- There is an option to include DATE/TIME on still images.

- Date Imprinting

1. In any mode other than Voice Recording mode, press the MENU button.
2. Press the LEFT/ RIGHT button and select the [SETUP] menu tab.
3. Select the [IMPRINT] menu by pressing the UP/ DOWN button and press the RIGHT button.
4. Use the UP and DOWN buttons to select the desired date imprint type, and then press the OK button.

[OFF] : The DATE & TIME will not be imprinted on the image file.

[DATE] : Only the DATE will be imprinted on the image file.

[DATE&TIME] : The DATE & TIME will be imprinted on the image file.

5. Press the menu button twice and the menu will disappear.

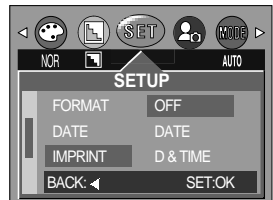

# Imprinting the recording date

## INFORMATION

- The Date & Time are imprinted at the bottom right side of the still image.
- The date will be imprinted as a DATE TYPE setting.
- TIME is imprinted in the following way : [Hour : Minute] and hours are shown using the 12 hour clock.
- The imprint function is applied only to still images.

## Function lamp

- You can turn on and off the function lamp located on the front of the camera.

### ● Setting the function lamp

1. In any mode other than Voice Recording mode, press the MENU button.
2. Press the LEFT/ RIGHT button and select the [SETUP] menu tab.
3. Select the [LAMP] menu by pressing the UP/ DOWN button and press the RIGHT button.
4. Select a desired sub menu by pressing the UP/ DOWN button and press the OK button.  
If [OFF] is selected : The function lamp will not light up.  
If [ON] is selected : The function lamp will light up.
5. Press the menu button twice and the menu will disappear.



### ● Description of the Function lamp

Function	Description
During power-on	7 color lights blink and then turns off when the camera is ready to take a picture
After an image is captured	The green lamp will blink once.
While recording a movie clip	The purple lamp will blink at a 1-second interval.
During voice recording	The blue lamp will blink at a 1-second interval.
When the self-timer is activated	Even if the function lamp is set to OFF, the self-timer LED will work. (See page 30.)

# Sound

- If you set the operation sound to ON, various sounds will be activated for camera startup, when button are pressed, and if there is a card error, so that you can be aware of the camera operation status.

## ● Setting Operation Sounds

1. In any mode other than Voice Recording mode, press the MENU button.
2. Press the LEFT/ RIGHT button and select the [SETUP] menu tab.
3. Select the [SOUND] menu by pressing the UP/ DOWN button and press the RIGHT button.
4. Select a desired sub menu by pressing the UP/ DOWN button and press the OK button.
  - [SOUND] sub menu : OFF/LOW/MEDIUM/HIGH
5. Press the menu button twice and the menu will disappear.



## LCD brightness

- You can adjust the LCD brightness.

## ● Adjusting LCD Brightness

1. In any mode other than Voice Recording mode, press the MENU button.
2. Press the LEFT/ RIGHT button and select the [SETUP] menu tab.
3. Select the [LCD] menu by pressing the UP/ DOWN button and press the RIGHT button.
4. Select a desired sub menu by pressing the UP/ DOWN button and press the OK button.
  - [LCD] sub menu : DARK, NORMAL, BRIGHT
5. Press the menu button twice and the menu will disappear.



# Selecting Video out type

- The Movie output signal from the camera can be NTSC or PAL.

Your choice of output will be governed by the type of device (monitor or TV, etc.) to which the camera is connected. PAL mode can support only BDGHI.

## ● Setting the Video Out Type

1. In any mode other than Voice Recording mode, press the MENU button.
2. Press the LEFT/ RIGHT button and select the [SETUP] menu tab.
3. Select the [VIDEO] menu by pressing the UP/ DOWN button and press the RIGHT button.
4. Select a desired sub menu by pressing the UP/ DOWN button and press the OK button.
  - [VIDEO] sub menu : NTSC, PAL
5. Press the menu button twice and the menu will disappear.



## ● Connecting to an external monitor

In RECORDING/ PLAY mode, you can view the stored still images or movie clips by connecting the camera to an external monitor via the A/V cable. When the camera is connected to an external monitor, the LCD monitor will be turned off automatically.

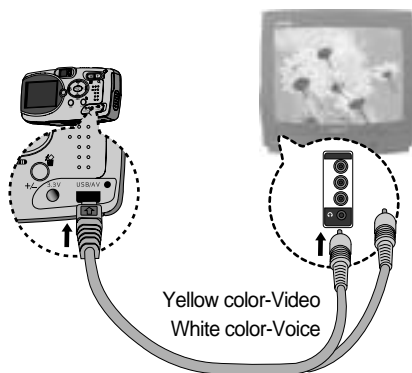

## INFORMATION

- NTSC : U.S.A, Canada, Japan, South Korea, Taiwan, Mexico.
- PAL : Australia, Austria, Belgium, China, Denmark, Finland, Germany, U.K., Holland, Italy, Kuwait, Malaysia, New Zealand, Singapore, Spain, Sweden, Switzerland, Thailand, Norway.
- When using a TV as an external monitor, you will need to select the external or AV channel of the TV.
- There will be a digital noise on the external monitor, but it is not a malfunction.
- If the image is not in the centre of the screen, use the TV controls to centre it.
- When the camera is connected to an external monitor, the menu will be visible on the external monitor and the menu functions are the same as those indicated on the LCD monitor.

# Quick view

- If you enable Quick View before capturing an image, you can view the image you just captured on the LCD monitor for the duration set in the [Q.VIEW] setup. Quick view is possible only with still images.

## ● Setting Quick View

1. In any mode other than Voice Recording mode, press the MENU button.
2. Press the LEFT/ RIGHT button and select the [SETUP] menu tab.
3. Select the [Q.VIEW] menu by pressing the UP/ DOWN button and press the RIGHT button.
4. Select a desired sub menu by pressing the UP/ DOWN button and press the OK button.



[OFF] : The quick view function can't be activated.

[1 ~ 5 SEC] : The captured image is briefly displayed during the selected time.

5. Press the menu button twice and the menu will disappear.

## ● Deleting Images in Quick View

You can delete images directly from the quick view screen.

If you select the [1~5SEC] sub menu at step 4, press the RIGHT button and the [DEL. ANS.] menu will be displayed.

5. Select the desired [DEL. ANS.] sub menu by pressing the UP/DOWN button.

Selecting [OFF] : A [DELETE?] message will not display.

Selecting [ON] : You can delete the captured image at once.



6. Press the menu button twice and the menu will disappear.

## ● Using the [DEL.ANS.] menu

If you select [ON] at the [DEL.ANS.] menu, a message as shown alongside will be displayed after taking a picture.

Pressing the OK button : the captured image is deleted.

Pressing the LEFT button : the captured image is stored.

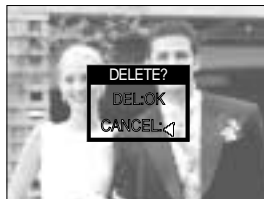

# Connecting an External Device (USB)

- You can select an external device to which you want to connect the camera using the USB cable.

## ● Selecting an External Device

1. In any mode other than Voice Recording mode, press the MENU button.
2. Press the LEFT/ RIGHT button and select the [SETUP] menu tab.
3. Select the [USB] menu by pressing the UP/ DOWN button and press the RIGHT button.
4. Select a desired sub menu by pressing the UP/ DOWN button and press the OK button.

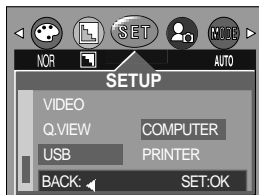

**COMPUTER** : Select this if you want to connect the camera to your PC. Refer to page 83 for instructions on how to connect the camera to your PC.

**PRINTER** : Select this if you want to connect the camera to your printer. Refer to page 58 for instructions on how to connect the camera to your printer.

5. Press the menu button twice and the menu will disappear.

## Initialization(RESET ALL)

- All camera menu and function settings will be restored to their default values. However, values for DATE/TIME, LANGUAGE, and VIDEO OUT will not be changed.

## ● Initializing the Camera

1. In any mode other than Voice Recording mode, press the MENU button.
2. Press the LEFT/ RIGHT button and select the [SETUP] menu tab.
3. Select the [RESET] menu by pressing the UP/ DOWN button and press the RIGHT button.
4. Select a desired sub menu by pressing the UP/ DOWN button and press the OK button.
  - If [NO] is selected : Settings will not be restored to their defaults.
  - If [YES] is selected : All settings will be restored to their defaults.
5. Press the menu button twice and the menu will disappear.





# Setting up the MYCAM menu

- You can set up a start up image, start up sound, shutter sound and AVATAR. Every camera working mode (with the exception of Voice recording mode) has the MyCAM menu.

Menu tab	Main menu	Sub menu		Page
	AVATAR	OFF		P.74
		CHANGE		
	S.IMAGE	OFF	IMAGE1	P.75
		IMAGE2	IMAGE3	
	S.SOUND	OFF	SOUND1	P.76
		SOUND2	SOUND3	
	SH.SOUND	OFF	SOUND1	P.76
		SOUND2	SOUND3	

## Avatar

- You can transfer avatar files created with the DigiStudio program to the camera and play them back in Play mode (SUCAXxxx.mov) or use the desired avatar as the startup image (SAVAXxxx.mov).

- In order to be able to save an avatar to the camera, the camera driver must be installed on your PC. For installation instruction, please refer to page 95.

- Avatar: The word "avatar" came from ancient Sanskrit and referred to the incarnation of a god that appears in this world. In computer terms, an avatar is a 3D or 2D graphic representation.

### ● Storing Avatars for the Startup Image

1. Connect the camera to your PC. (See page 83.)
2. Open Windows Explorer, select the folder in which your avatars are located (C:\My Avatar), and then select avatar(s) for the startup image (SAVAXxxx.mov).
3. Right-click on the avatar and select [Copy].
4. Select the DCIM\AVATAR folder in the removable drive.
5. Right-click on the removable drive and select [Paste] to copy the avatar(s) to the memory card.



# Avatar

## ● Storing Avatars for the Startup Image and Selecting One as the Startup Image

1. In a mode other than Voice Recording mode, press the MENU button.
2. Use the LEFT and RIGHT buttons to select the [MYCAM] menu tab.
3. Select [AVATAR] menu by pressing the UP/ DOWN button and press the RIGHT button.
4. Select a desired sub menu by pressing the UP/ DOWN button and press the OK button.

If [NO] is selected : The avatar will not be used as the startup image during power-on.

If [CHANGE] is selected: Avatars will be displayed in thumbnail format.

Use the UP, DOWN, LEFT, and RIGHT buttons to select the desired avatar, and then press the OK button.

The avatar playback screen will appear.

5. Press the PLAY/PAUSE button (▶/⏸) to play back the avatar. Use the LEFT and RIGHT buttons to select the previous or next avatar file.
6. Press the OK button to accept the selected avatar and to register it as the startup image.

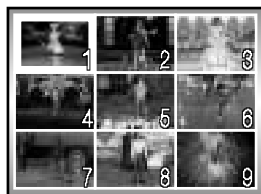





## ● Storing Playable Avatars

1. Connect the camera to your PC. (See page 83.)
2. Open Windows Explorer, select the folder in which your avatars are located (C:\My Avatar), and then select avatar(s) for playback (SUCAxxxx.mov).
3. Right-click on the avatar and select [Copy].
4. Select the DCIM\100SSCAM folder in the removable drive.
5. Right-click on the removable drive and select [Paste] to copy the avatar(s) to the memory card.



# Avatar

## ● Playing Back an Avatar

1. Press the PLAY (  ) button to select Play mode.
2. The last image taken will be displayed on the LCD monitor.
3. Use the LEFT and RIGHT buttons to select an avatar file for playback.
4. Press the PLAY/PAUSE (  ) button. The selected avatar will be played.
  - To pause playback of the avatar file, press the PLAY/PAUSE (  ) button again.
  - During avatar playback, press the LEFT or RIGHT button to rewind or fast-forward the avatar file.
  - To stop playback of the avatar file, press the PLAY/PAUSE (  ) button, and then press the LEFT or RIGHT button.



## INFORMATION

- When selecting or playing back an avatar, please use the adapter (3.3V 2.0A) for the camera.
- You can store as many avatars as memory capacity allows.
- When the avatar is selected, the startup image will be replaced by the avatar.
- Do not arbitrarily change the folder name of the Memory Stick Duo. If you do, the camera cannot recognize avatar files.
- If you create an avatar from a video, the picture quality may deteriorate slightly.

## Start up image

- You can select the image that is first displayed on the LCD monitor whenever the camera is turned on. If both the avatar and startup image are selected, only the avatar will be displayed. To view the startup image, cancel the selection of an avatar.
- Setting Startup Image
  1. In a mode other than Voice Recording mode, press the MENU button.
  2. Press the LEFT/ RIGHT button and select [MYCAM] menu tab.
  3. Select [S.IMAGE] menu by pressing the UP/ DOWN button and press the RIGHT button.
  4. Select a desired sub menu by pressing the UP/ DOWN button and press the OK button.
  5. Press the menu button twice and the menu will disappear.

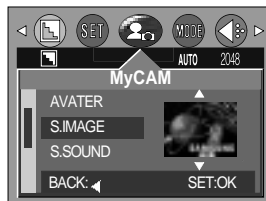

# Start up image

## INFORMATION

- Only an image that is saved as a LOGO in the [RESIZE] sub menu can be used as the start up image.
- The logo image will not be deleted by the [DEL.ALL] or [FORMAT] menu.

## Start up sound

- You can select the sound that is activated whenever the camera is turned on.

### ● Setting the Startup Sound

1. In any mode other than Voice Recording mode, press the MENU button.
2. Press the LEFT/ RIGHT button and select the [MYCAM] menu tab.
3. Select the [S.SOUND] menu by pressing the UP/ DOWN button and press the RIGHT button.
4. Select a desired sub menu by pressing the UP/ DOWN button and press the OK button.
5. Press the menu button twice and the menu will disappear.



## Shutter sound

- You can select the shutter sound.

### ● Selecting the Shutter Sound

1. In any mode other than Voice Recording mode, press the MENU button.
2. Press the LEFT/ RIGHT button and select the [MYCAM] menu tab.
3. Select the [SH.SOUND] menu by pressing the UP/ DOWN button and press the RIGHT button.
4. Select a desired sub menu by pressing the UP/ DOWN button and press the OK button.
5. Press the menu button twice and the menu will disappear.

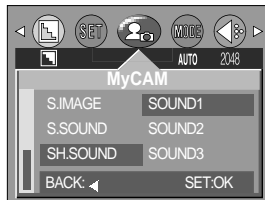

# List of camera functions

- D : Default  
 - : There is no related menu.  
 K : Altered settings and values are maintained even after the camera is turned off. (KEEP)  
 R : A default value is restored when the camera is turned off. (RETURN)  
 O : A default value is restored after the function has been executed. (ONCE)  
 ■ : Settings can be stored in Myset mode.

Function \ Camera working mode		Recording			Movie clip	Play			Voice recording
		Auto	Night	Manual		Still image	Movie clip	Voice memo	
SIZE	2048x1536	K(D)	K(D)	K(D)	-	-	-	-	-
	2048x1360	K	K	K	-	-	-	-	-
	1600x1200	K	K	K	-	-	-	-	-
	1024x768	K	K	K	-	-	-	-	-
	640x480	K	K	K	-	-	-	-	-
	320x240	-	-	-	K(D)	-	-	-	-
	160x120	-	-	-	K	-	-	-	-
QUALITY	S.FINE	K	K	K	-	-	-	-	-
	FINE	K(D)	K(D)	K(D)	-	-	-	-	-
	NORMAL	K	K	K	-	-	-	-	-
	HIGH(20fps)	-	-	-	K(D)	-	-	-	-
	LOW(15fps)	-	-	-	K	-	-	-	-
METERING	MULTI	K(D)	K(D)	K(D)	K(D)	-	-	-	-
	SPOT	R	-	K	-	-	-	-	-
ISO	AUTO	K(D)	K(D)	K(D)	K(D)	-	-	-	-
	100	R	-	K	-	-	-	-	-
	200	R	-	K	-	-	-	-	-
	400	R	-	K	-	-	-	-	-

# List of camera functions

Function \ Camera working mode		Recording			Movie clip	Play			Voice recording
		Auto	Night	Manual		Still image	Movie clip	Voice memo	
White balance	Auto	K(D)	K(D)	K(D)	K(D)	-	-	-	-
	Daylight	R	-	K	R	-	-	-	-
	Cloudy	R	-	K	R	-	-	-	-
	Fluorescent	R	-	K	R	-	-	-	-
	Tungsten	R	-	K	R	-	-	-	-
	User set	R	-	K	R	-	-	-	-
EFFECT	NORMAL	K(D)	K(D)	K(D)	K(D)	-	-	-	-
	B & W	R	-	K	R	-	-	-	-
	SUNSET	R	-	K	R	-	-	-	-
	SEPIA	R	-	K	R	-	-	-	-
	RGB	R	-	K	R	-	-	-	-
Sharpness	SOFT	R	-	K	-	-	-	-	-
	NORMAL	K(D)	K(D)	K(D)	-	-	-	-	-
	VIVID	R	-	K	-	-	-	-	-
Flash	Auto	K(D)	-	K(D)	-	-	-	-	-
	Red eye (with Auto)	R	-	K	-	-	-	-	-
	Fill-in	R	-	K	-	-	-	-	-
	Slow sync. (with Red eye)	R	K(D)	K	-	-	-	-	-
	Off	R	K	K	K(D)	-	-	-	-
Exposure compensation	-0.5 ~ -2.0EV (1/2 steps)	R	-	K	-	-	-	-	-
	0.0EV	K(D)	K(D)	K(D)	-	-	-	-	-
	-0.5 ~ -2.0EV (1/2 steps)	R	-	K	-	-	-	-	-
Manual Exposure compensation	AUTO	-	K	-	-	-	-	-	-
	F2.8/F4.8	-	K(D)	-	-	-	-	-	-
	F2.8~5.6/F4.8~10	-	R	-	-	-	-	-	-

# List of camera functions

Function		Camera working mode		Recording			Movie clip	Play			Voice recording
				Auto	Night	Manual		Still image	Movie clip	Voice memo	
Self-timer	Off	K(D)	K(D)	K(D)	K(D)	-	-	-	-		
	2sec	R	R	R	-	-	-	-			
	10sec	R	R	R	-	-	-	-			
Voice recording	Do not record	-	-	-	-	-	-	-	-		
	Record	-	-	-	-	-	-	-	K(D)		
Voice memo	Do not record	K(D)	K(D)	K(D)	-	K(D)	-	-	-		
	Record	R	R	R	K(D)	R	-	-	-		
Auto focus	80 cm ~ infinity	K(D)	K(D)	K(D)	K(D)	-	-	-	-		
	5 ~ 80cm	R	-	K	K	-	-	-	-		
Slide show (1sec step)	1~10SEC	-	-	-	-	K	-	-	-		
	OFF	-	-	-	-	K(D)	-	-	-		
	No repeat	-	-	-	-	K	-	-	-		
	Repeat	-	-	-	-	K(D)	-	-	-		
PROTECT	UNLOCK	-	-	-	-	K(D)	K(D)	K(D)	-		
	LOCK	-	-	-	-	K	K	K	-		
D P O F	STAND ARD	ONE PIC	0 PRINTS	-	-	-	-	K(D)	-	-	-
			1~30 PRINTS	-	-	-	-	K	-	-	-
		ALL PICS	0 PRINTS	-	-	-	-	K(D)	-	-	-
			1~30 PRINTS	-	-	-	-	K	-	-	-
	INDEX	NO	-	-	-	-	K(D)	-	-	-	
		YES	-	-	-	-	K	-	-	-	
	SIZE	DEFAULT	-	-	-	-	K(D)	-	-	-	
		3X5	-	-	-	-	R	-	-	-	
		4X6	-	-	-	-	R	-	-	-	
		5X7	-	-	-	-	R	-	-	-	
		8X10	-	-	-	-	R	-	-	-	
	CANCEL	STANDARD	-	-	-	-	K(D)	-	-	-	
INDEX		-	-	-	-	R	-	-	-		
SIZE		-	-	-	-	R	-	-	-		

# List of camera functions

Function		Camera working mode	Recording			Movie clip	Play			Voice recording	
			Auto	Night	Manual		Still image	Movie clip	Voice memo		
P i c t B r i d g e	IMAGES	ONE PIC	-	-	-	-	K(D)	-	-	-	
		ALL PICS	-	-	-	-	O	-	-	-	
	S E T U P	DEFAULT	-	-	-	-	K(D)	-	-	-	
		CUSTOM	-	-	-	-	O	-	-	-	
		C U S T O M I Z E	POSTCARD	-	-	-	-	K(D)	-	-	-
			4X6	-	-	-	-	R	-	-	-
			8X10	-	-	-	-	R	-	-	-
			A6	-	-	-	-	R	-	-	-
			A4	-	-	-	-	R	-	-	-
			B5	-	-	-	-	R	-	-	-
		L A Y O U T	FULL	-	-	-	-	K(D)	-	-	-
			1	-	-	-	-	R	-	-	-
			2	-	-	-	-	R	-	-	-
			4	-	-	-	-	R	-	-	-
			6	-	-	-	-	R	-	-	-
			8	-	-	-	-	R	-	-	-
		P A P E R	INDEX	-	-	-	-	R	-	-	-
			PLAIN	-	-	-	-	K(D)	-	-	-
			PHOTO	-	-	-	-	R	-	-	-
		Q U A L I T Y	FAST PHOTO	-	-	-	-	R	-	-	-
			DRAFT	-	-	-	-	K(D)	-	-	-
			NORMAL	-	-	-	-	R	-	-	-
	D A T E	FINE	-	-	-	-	R	-	-	-	
		OFF	-	-	-	-	K(D)	-	-	-	
	F L E W I E	ON	-	-	-	-	R	-	-	-	
		OFF	-	-	-	-	K(D)	-	-	-	
	PRINT		-	-	-	-	O	-	-	-	
	DPOF PRN		-	-	-	-	O	-	-	-	
	R E S E T	NO	-	-	-	-	O	-	-	-	
		YES	-	-	-	-	O	-	-	-	



# List of camera functions

Function		Camera working mode	Recording			Movie clip	Play			Voice recording
			Auto	Night	Manual		Still image	Movie clip	Voice memo	
E d i t	Trimming	No	-	-	-	-	K(D)	-	-	-
		YES	-	-	-	-	O	-	-	-
	RESIZE	1600X1200	-	-	-	-	O	-	-	-
		1024X768	-	-	-	-	O	-	-	-
		640X480	-	-	-	-	O	-	-	-
	ROTATE	LOGO	-	-	-	-	O	-	-	-
		NO	-	-	-	-	O	-	-	-
Deletion	YES	-	-	-	-	O	-	-	-	
	No	-	-	-	-	O	O	O	-	
DEL.ALL	YES	-	-	-	-	O	O	O	-	
	No	-	-	-	-	K(D)	K(D)	K(D)	-	
FILE	RESET					K(D)			-	
	SERIES					K			-	
PWR OFF	CANCEL					K			-	
	ON	1, 2 MIN				K			-	
		3 MIN				K(D)			-	
		4~10 MIN				K			-	
LANGUAGE	16 languages					K			-	
FORMAT	NO					K(D)			-	
	YES					O			-	
DATE	2003/01/01					K			-	
	~ 2050/12/31					K			-	
TIME	12:00 A.M					K			-	
	~11:59 P.M					K			-	
IMPRINT	OFF					K(D)			-	
	DATE					K			-	
	D & TIME					K			-	

# List of camera functions

Function		Camera working mode	Recording			Movie clip	Play			Voice recording
			Auto	Night	Manual		Still image	Movie clip	Voice memo	
Date type		Y/M/D				K(D)				-
		M/D/Y				K				-
		D/M/Y				K				-
SOUND		OFF				K				-
		LOW				K				-
		MEDIUM				K(D)				-
		HIGH				K				-
LCD		DARK				K				-
		NORMAL				K(D)				-
		BRIGHT				K				-
VIDEO		NTSC				K				-
		PAL				K				-
Q.VIEW		OFF				K				-
		1 sec.				K(D)				-
		2~5 sec.				K				-
		DEL.ANS.	OFF				K(D)			
	ON					K				-
USB		COMPUTER				K(D)				-
		PRINTER				K				-
RESET		NO				K				-
		YES				K(D)				-
AVATAR		OFF				K(D)				-
		CHANGE				K				-
S.IMAGE		IMAGE1				K(D)				-
		OFF, IMAGE 2, 3				K				-
S.SOUND		SOUND 1				K(D)				-
		OFF, SOUND 2, 3				K				-
SH.SOUND		SOUND 1				K(D)				-
		OFF, SOUND 2, 3				K				-

※ The list of camera functions is subject to change without prior notice.

# Starting PC mode

- If you connect the USB cable to a USB port on your PC and then turn on the power, the camera will automatically switch to "computer connection mode".
- In this mode, you can download stored images to your PC through the USB cable.
- The LCD monitor is always turned off in PC mode.
- The camera status lamp will illuminate when the files are transferring via the USB connection.

## ■ Connecting the camera to a PC

1. Turn the PC power on.
2. Turn the camera power on.
3. In any mode other than Voice Recording mode, press the MENU button.
4. Press the LEFT/ RIGHT button and select the [SETUP] menu tab.
5. Select the [USB] menu by pressing the UP/ DOWN button and press the RIGHT button.
6. Use the UP and DOWN buttons to select [COMPUTER], and then press the OK button.
7. Press the menu button twice and the menu will disappear.
8. Connect the PC and the camera via the USB cable.
  - Insert the small plug of the USB cable into the camera USB connection terminal.
  - Insert the large connector of the USB cable into the USB port of the PC.
  - The plugs must be firmly inserted.

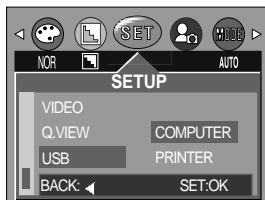

- ※If you selected [Printer] in Step 6, when you connect the camera to your printer, the [SET USB] message will be displayed on the LCD monitor and the connection will not be established. In this case, disconnect the USB cable, and then follow the procedure from Step 3 and onward.

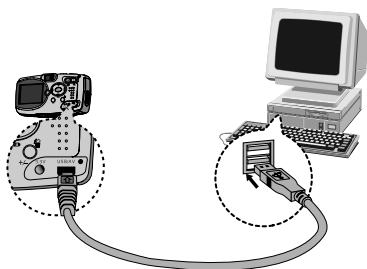

- ## ■ Disconnecting the camera and PC : Refer to page 110 (Removing the removable disk).

## INFORMATION

- The camera driver must be installed before using PC mode.
- To save battery power, it is recommended that you use an AC adapter (Optional) when connecting the camera to a computer

# Starting PC mode

## ■ Downloading stored images

You can download the still images stored on the camera to your PC's hard disk and print them or use photo editing software to edit them.

1. Use the supplied USB cable to connect the camera to your computer and then turn on the camera.

2. On your computer's desktop display, select [My computer] and double click [Removable Disk → DCIM → 100SSCAM]. The image files will then be displayed.



3. Select an image and press the right mouse button.

4. A pop-up menu will open. Click the [Cut] or [Copy] menu

[Cut] : cuts a selected file.

[Copy] : copies files.



5. Click a folder that you want to paste the file into.

6. Press the right mouse button and a pop-up menu will open. Click [Paste].



# Starting PC mode

7. An image file is transferred from the camera to your PC.



- By using [Digimax Viewer], you can see the stored images in the memory directly on the PC monitor and you can copy or move the image files. (p.112)

## Important notes

Be sure to observe the following precautions!

- This unit contains precision electronic components. Do not use or store this unit in the following locations.
  - Areas exposed to severe changes in temperature and humidity.
  - Areas exposed to dust and dirt.
  - Areas exposed to direct sunlight or the inside of a vehicle in hot weather.
  - Environments where there is high magnetism or excessive vibration.
  - Areas with high explosives or highly flammable materials.
- Do not let the unit come into contact with dust, vinyl goods, or chemicals, such as insecticides, for an extended period of time.
- Sand can be particularly troublesome to cameras.
  - Do not let sand get inside the unit when using it on beaches, coastal dunes, or other areas where there is lots of sand.
  - Doing so may result in failure or may permanently render the unit unusable.
- Extremes in temperature may cause problems.
  - If the camera is transferred from a cold to a warm and humid environment, condensation can form on the delicate electronic circuitry.  
If this occurs, turn the camera off and wait for at least 1 hour until all moisture is dispersed.  
Moisture build up can also occur in the memory card. If this happens, turn off the camera and remove the memory card. Wait until the moisture has dispersed.

# Important notes

## ■ Caution on Using the Lens

- If the lens is subjected to direct sunlight, it could result in discoloration and deterioration of the image sensor.
- Do not apply excessive force to the zoom lens.
- Pay attention not to get fingerprints or foreign substances on the surface of the lens.

■ If the digital camera is not used for a long period, an electric discharge can occur. It is a good idea to remove the batteries and the memory card if you do not intend using the camera for an extended period of time.

■ If the camera is exposed to an electronic interference, it will turn itself off to protect the memory card.

## ■ Camera Maintenance

- Use a soft brush (available from photo stores) to gently clean the lens and LCD assemblies. If this does not work, lens-cleaning paper with lens cleaning fluid can be used. Clean the camera body with a soft cloth. Do not allow this camera to come into contact with solvent materials such as benzol, insecticide, thinners etc. This may damage the body shell of the camera and also affect its performance. Rough handling can damage the LCD monitor. Take care to avoid damage and keep the camera in its protective carry case at all times when not in use.

■ Do not attempt to disassemble or modify the camera.

■ Under certain conditions, static electricity can cause the flash unit to fire. This is not harmful to the camera and is not a malfunction.

■ When images are uploaded or downloaded, the data transfer may be affected by static electricity. In this case, disconnect and re-connect the USB cable before trying the transfer again.

# Warning indicator

There are several warnings that may appear on the LCD display

Warning indicator	Causes	Remedy
CARD ERROR !	<ul style="list-style-type: none"><li>- Memory card error</li></ul>	<ul style="list-style-type: none"><li>- Turn off the camera power and turn it on again</li><li>- Insert the memory card again</li><li>- Format the memory card (p.66)</li></ul>
CARD FULL !	<ul style="list-style-type: none"><li>- There is insufficient memory capacity to take an image</li></ul>	<ul style="list-style-type: none"><li>- Insert a new memory card</li><li>- Delete unnecessary image files to free up some memory</li></ul>
NO IMAGE !	<ul style="list-style-type: none"><li>- There are no images stored on the memory card</li></ul>	<ul style="list-style-type: none"><li>- Take images</li><li>- Insert a memory card that is holding some images</li></ul>
NO CARD !	<ul style="list-style-type: none"><li>- A memory card is not inserted</li><li>- The camera can't recognize the memory card</li></ul>	<ul style="list-style-type: none"><li>- Insert a memory card</li><li>- Insert the memory card again</li><li>- Turn off the camera power and turn it on again</li></ul>
FILE ERROR !	<ul style="list-style-type: none"><li>- File error</li><li>- Memory card error</li></ul>	<ul style="list-style-type: none"><li>- Format the memory card</li><li>- Contact a camera service center</li></ul>
LOW BATTERY !	<ul style="list-style-type: none"><li>- There is low battery capacity</li></ul>	<ul style="list-style-type: none"><li>- Insert fresh batteries</li></ul>
CARD LOCKED !	<ul style="list-style-type: none"><li>- The memory card is locked</li></ul>	<ul style="list-style-type: none"><li>- Slide the write protect switch to the bottom of the memory card.(p.16)</li></ul>
LOW LIGHT !	<ul style="list-style-type: none"><li>- When taking pictures in dark places</li></ul>	<ul style="list-style-type: none"><li>- Use a tripod and take pictures in Flash Photography mode.</li></ul>

# Before contacting a service center

Please check the following

Symptom	Causes	Remedy
The camera doesn't switch on	<ul style="list-style-type: none"> <li>- There is low battery capacity</li> <li>- An AC Power Adapter is not connected</li> <li>- Batteries are inserted incorrectly with the reverse polarities.</li> </ul>	<ul style="list-style-type: none"> <li>- Insert fresh batteries</li> <li>- Connect an AC Power Adapter</li> <li>- Insert the batteries according to the polarity marks (+, -).</li> </ul>
The camera power ceases whilst in use	<ul style="list-style-type: none"> <li>- The batteries are exhausted</li> <li>- The Camera is turned off automatically.</li> <li>- The Adapter plug is not connected securely</li> </ul>	<ul style="list-style-type: none"> <li>- Insert fresh batteries</li> <li>- Slide the power switch to reactivate camera</li> <li>- Remove and re-insert the plug</li> </ul>
Batteries drain quickly	<ul style="list-style-type: none"> <li>- The Camera is being used in low temperatures</li> </ul>	<ul style="list-style-type: none"> <li>- Keep the camera in warm conditions (i.e. inside a coat or jacket) and only remove it in order to take images</li> </ul>
Camera does not take images when pressing the Shutter button	<ul style="list-style-type: none"> <li>- The memory card is not inserted</li> <li>- There is insufficient memory capacity</li> <li>- The memory card has not been formatted</li> <li>- The memory card is exhausted</li> <li>- The camera's power is off</li> <li>- The batteries are exhausted</li> <li>- The memory card is locked</li> <li>- Batteries are inserted incorrectly with the reverse polarities.</li> </ul>	<ul style="list-style-type: none"> <li>- After turning the camera off, insert a new memory card</li> <li>- Delete unnecessary image files</li> <li>- Format the memory card (p.66)</li> <li>- Insert a new memory card</li> <li>- Turn the camera power on</li> <li>- Insert fresh batteries</li> <li>- Slide the write protect switch to the bottom of the memory card</li> <li>- Insert the batteries according to the polarity marks (+, -).</li> </ul>
The camera suddenly stops working while in use.	<ul style="list-style-type: none"> <li>- The camera was stopped due to a malfunction.</li> </ul>	<ul style="list-style-type: none"> <li>- Press the power button for longer than 3 seconds. The camera will restart to its normal operation state.</li> </ul>



# Before contacting a service center

Symptom	Causes	Remedy
The images are unclear	<ul style="list-style-type: none"><li>- A picture was taken within 0.8 m from the subject without setting an appropriate macro mode.</li><li>- Taking a picture beyond the flash range</li><li>- The lens is smudged or dirty.</li></ul>	<ul style="list-style-type: none"><li>- If the subject is closer than 0.8m, select macro shot mode.</li><li>- Take a picture within the flash range</li><li>- Clean the lens</li></ul>
The flash does not fire	<ul style="list-style-type: none"><li>- Flash off mode has been selected</li></ul>	<ul style="list-style-type: none"><li>- Dis-engage flash off mode</li></ul>
Incorrect date and time is displayed	<ul style="list-style-type: none"><li>- The date and time have been set incorrectly or the camera has adopted the default settings</li></ul>	<ul style="list-style-type: none"><li>- Reset the date and time correctly</li></ul>
The camera buttons do not operate	<ul style="list-style-type: none"><li>- Camera malfunction</li></ul>	<ul style="list-style-type: none"><li>- Remove /re-insert batteries and switch the camera on</li></ul>
A card error has occurred while the memory card is in the camera.	<ul style="list-style-type: none"><li>- Incorrect memory card format</li></ul>	<ul style="list-style-type: none"><li>- Re-format the memory card (p.66)</li></ul>
The images don't play back	<ul style="list-style-type: none"><li>- Incorrect file name. (Violation of DCF format)</li></ul>	<ul style="list-style-type: none"><li>- Do not change the image file name.</li></ul>

# Before contacting a service center

Symptom	Causes	Remedy
Colour of image is different to the original scene	<ul style="list-style-type: none"> <li>- White balance setting is incorrect.</li> </ul>	<ul style="list-style-type: none"> <li>- Select appropriate White balance.</li> </ul>
Images are too bright	<ul style="list-style-type: none"> <li>- Exposure is excessive.</li> </ul>	<ul style="list-style-type: none"> <li>- Reset exposure compensation.</li> </ul>
No image on external monitor	<ul style="list-style-type: none"> <li>- The external monitor has not been connected properly with the camera.</li> <li>- There are incorrect files in the memory card.</li> </ul>	<ul style="list-style-type: none"> <li>- Check the connection cables.</li> <li>- Insert a memory card that has correct files.</li> </ul>
When using the PC's explorer, the [Removable Disk] file does not show	<ul style="list-style-type: none"> <li>- Cable connection is incorrect.</li> <li>- The camera is off.</li> <li>- There are no batteries, the batteries are exhausted or the AC adapter is not connected.</li> <li>- The operating system is not Windows 98, 98SE, 2000, ME, XP/ Mac OS 9.x~10.2. Alternatively the PC does not support USB.</li> <li>- The USB driver is not installed.</li> </ul>	<ul style="list-style-type: none"> <li>- Check the connection.</li> <li>- Turn the camera on.</li> <li>- Insert new batteries or check the adapter connection.</li> <li>- Install Windows 98, 98SE, 2000, ME, XP/ Mac OS 9.x~10.2 to PC that supports USB.</li> <li>- Install a [USB Storage Driver].</li> </ul>

# Specifications

Image Sensor	Type	1/2.7" CCD
	Effective Pixel	Approx. 3.2 Mega-pixel
	Total Pixel	Approx. 3.3 Mega-pixel
Lens	Focal Length	SHD Lens f = 5.8 ~ 17.4mm (35mm film equivalent : 38 ~ 114mm)
	F No.	F2.8 ~ F4.8
	Digital Zoom	Still Image mode : 1.0X ~ 3.0X Play mode : 1.0X ~ 5.0X (depends on image size)
Viewfinder	Optical Viewfinder	Real image optical viewfinder
	LCD Monitor	1.5" color TFT LCD
Focusing	Type	TTL auto focus
	Range	Normal : 80cm ~ infinity Macro : 5 ~ 80cm (Wide), 50 ~ 80cm (Tele)
Shutter	Type	Mechanical and Electronic shutter
	Speed	2 ~ 1/2,000 sec.(16 ~ 1/2,000 sec. in Night Mode)
Exposure	Control	Program AE Metering : Multi, Spot
	Compensation	±2EV (0.5EV steps)
	ISO Equivalent	Auto, 100, 200, 400
	Manual	Long-time Shutter Function only in Night Mode - Shutter Speed : 16 ~ 1/8 sec. - Aperture : F2.8 / F4.8 selectable
Flash	Modes	Auto, Auto & Red-eye reduction, Fill-in flash, Slow sync, Flash off
	Range	Wide : 0.2 ~ 3.0m, Tele : 0.5 ~ 2.0m
	Recharging Time	Approx. 6 sec.
Sharpness		Soft, Normal, Vivid
Effect		Normal, B&W, Sunset, Sepia, RGB
White Balance		Auto, Daylight, Cloudy, Fluorescent, Tungsten, Custom
Voice Recording		Voice Record (max. 1 hour) Voice Memo on Still Image (max. 10 sec.)
Date Imprinting		Date&Time, Date, Off (user selectable)
Shooting	Still Image	Modes : Auto, Manual, Night, Self-timer : 10 sec., 2 sec.
	Movie Clip	With Voice (Recording Time : In proportion to memory capacity) Resolution : 320x240, 160x120 Frame Rate : 20fps, 15fps
Storage	Media	Memory Stick Duo (up to 256MB guaranteed, Memory Stick PRO Duo supported)
	File Format	Still Image : JPEG (DCF), EXIF 2.2, DPOF 1.1, PictBridge 1.0 Movie Clip : MOV (MPEG-4) Voice Clip : WAV (G.711)
	Image Size	2048 : 2048x1536 pixels, 2048P : 2048x1360 pixels, 1600 : 1600x1200 pixels, 1024 : 1024x768 pixels, 640 : 640x480 pixels

# Specifications

Storage	Capacity (32MB)	2048 : Super fine 17, Fine 33, Normal 50 2048P : Super fine 19, Fine 38, Normal 56 1600 : Super fine 27, Fine 54, Normal 82 1024 : Super fine 66, Fine 132, Normal 198 640 : Super fine 169, Fine 336, Normal 501 * These figures are measured under Samsung's standard conditions and may vary depending on shooting conditions and camera settings.
	Format	Single Image, Thumbnails, Slide Show, Movie Clip
Image Play	Edit	Trimming, Rotating, Resizing
	Interface	Digital output connector : USB 1.1 Audio : Mono Video output : NTSC, PAL (user selectable) DC power input connector : 3.3V
Power Source	Rechargeable 3.7V Li-ion battery (SLB-1037) or 3V Lithium battery (CP1) * Included battery may vary depending on sales region. AC Adapter (optional) : SAC-32 (DC 3.3V, 2A)	
Dimensions (WxHxD)	102 x 53.8x 31.6 mm	
Weight	Approx. 119g (without batteries and card)	
Operating Temperature	0 ~ 40 °C	
Operating Humidity	5 ~ 85%	
Software	Camera Driver	Storage Driver (Windows98/98SE/2000/ME/XP, Mac OS 9.x or later)
	Application	QuickTime Player 6.3, MGI PhotoSuite 3 SE, Digimax Viewer 2.1, DigiStudio
Special Features	MPEG-4 Movie Clip, 3D Avatar (Character) Loading Screen, 7 Color Function Lamp, RGB Color Effect	

System Requirements	Digimax U-CA 3
For Windows	PC with processor better than MMX Pentium 233MHz (XP : Pentium II 300MHz) Windows 98/98SE/2000/ME/XP Minimum 32MB RAM (XP : 128MB) 140MB of available hard-disk space USB port CD-ROM drive 800x600 pixels, 16-bit colour display compatible monitor (24-bit color display recommended)
For Macintosh	Power Mac G3 or later Mac OS 9.x ~ 10.2 Minimum 64MB RAM 110MB of available hard-disk space USB port CD-ROM drive QuickTime 4.0 or later for Movie Clip

※ Specifications are subject to change without prior notice.

# Software Notes

Please ensure that you read the instruction manual carefully before use.

- The attached software is a camera driver and image editing software tool for Windows.
- Under no circumstances should all or part of either the software or the user manual be reproduced.
- Copyrights for software are licensed only for use with a camera.
- In the unlikely event of a manufacturing fault, we will repair or exchange your camera. We cannot, however, be held responsible in any way for damage caused by inappropriate use.
- Using a Hand-made PC or a OS(Operating System) that has not been guaranteed by the manufacturer is not covered by the Samsung warranty.
- Before reading this manual, you should have a basic knowledge of computers and O/S (Operating Systems).

## About the software

After inserting the CD-ROM provided with this camera into the CD-ROM drive, the following window should automatically run.

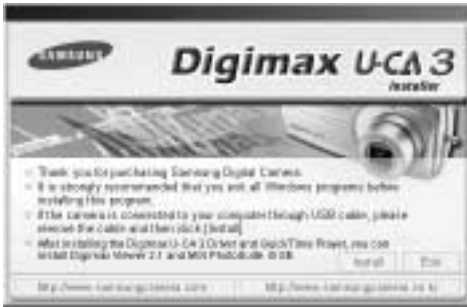

Before connecting the camera to the PC, you should first install the camera driver.

- **Camera driver** : This enables images to transfer between the camera and PC. This camera uses the USB Storage Driver as the camera driver. You can use the camera as a USB card reader.

After installing the driver and connecting this camera to the PC, you can find [Removable Disk] in [Windows Explorer] or [My computer]. A USB Storage Driver is provided only for Windows. A USB Driver for MAC is not included with the Application CD. But you can use the camera with Mac OS 9.0~10.2.

# Software Notes

- **QuickTime Player** : The program for playing back QuickTime movies (.mov). It can also play video files compressed with MPEG4 codec.
- **Digimax Viewer 2.1** : This is a program for viewing stored images.  
You can see the stored images in the memory directly on a PC monitor. You can also copy, move or delete the images and enlarge /downscale the image sizes with Digimax Viewer. This software is only compatible with Windows.
- **MGI PhotoSuite III SE**: Image editing program  
You can edit or store still images that you download from the camera.  
This software is only compatible with Windows.
- **DigiStudio**: Software for creating 3D avatars.  
You can store 3D avatar files on the camera and use one of the avatar as the startup image.  
Please be sure to check the system requirements for the software before installing. This software is only compatible with Windows.

DigiStudio		
	Recommended System Requirements	Minimum System Requirements
CPU	Pentium III 500Mhz	Pentium II 400Mhz
RAM	128MB	64MB
Graphic Card	Graphic card with 3D acceleration and at least 16MB of video RAM	Graphic card with 3D acceleration and at least 8MB of video RAM
Sound Card	16 Bit Stereo Sound Card	
Hard Disk	150MB or more available space	
Operating System	Windows 98SE/2000/ME/XP	
Web Browser	Internet Explorer 5.0 or later	

## INFORMATION

- Be sure to check the system requirements before installing the driver.
- You should allow 5~10 seconds for running the automatic setup program according to the capability of the computer. If the frame does not show, run the [Windows Explorer] and select [samsung.exe] in the CD-ROM Drive root directory.

# Setting up the application software

To use this camera with a PC, install the application software first.

After this has been done, the stored images in the camera can be moved to the PC and can be edited by an image editing program.

## INFORMATION

- Close other programs before installing the application software.
- Before installing the application software, disconnect the USB connection.

You can visit the Samsung web-site through the internet.

<http://www.samsungcamera.com> : English

<http://www.samsungcamera.co.kr> : Korean

1. Click the [Install] menu in the Autorun frame.

The U-CA 3 camera driver is installed automatically.

[Click !]

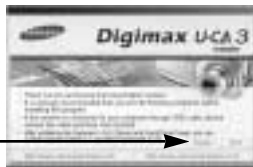

2. Installation is complete.

Click the [Finish] button.

[Click !]



3. Click [Next >] to begin installing QuickTime.

[Click !]



4. A Welcome window will appear.

Click [Next >] to proceed to the next screen.

[Click !]

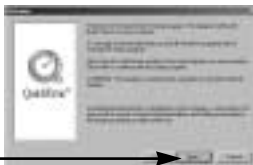

# Setting up the application software

6. The Software License Agreement window will open, asking you to agree to the licensing. Use the button on the bottom left to select the language of your choice, and then click [Agree] to accept the license agreement. The installation will proceed to the next stage. If you do not agree to the license agreement, click [Disagree]. The installation will be canceled. If the language of your choice is not listed, please select [English].



6. A window will open, asking you to select a destination folder where the files will be copied to. Click [Next >]. To copy the files to another folder, click [Browse..] Browse to a folder you want to copy the files to.



7. The Choose Installation Type window will open. Click [Next >].

[Minimum] : Installs required files only.  
[Recommended] : Installs required files and the most commonly used optional files.

\* When using the DigiStudio program, please be sure to select [Recommended].

[Custom] : Allows you to install only the components you choose.



8. A window will open, asking you to choose a folder to which program icons will be added. Click [Next >]. If you want to add the program icons to a different folder, choose another folder, and then click [Next >].



9. The Enter Registration window appears.

Enter your name and organization in the respective fields, and then click [Next >].

You do not have to enter a registration number.





# Setting up the application software

- ※ The QuickTime program folder will appear. Click on the Close button to close the folder.



- 10. The QuickTime Settings - Introduction window appears. Click [Next >].

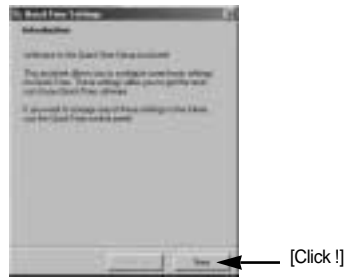

- 11. Set the transfer rate for downloading content from the Internet, and then click [Next >].

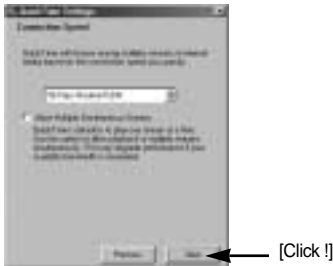

- 12. Set up your browser for QuickTime plug-in. Click [Next >].



- 13. Specify the file types you want to associate with QuickTime. Click [Finish].

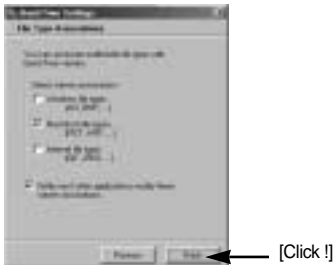

- 14. Installation is complete. Click [Close].



# Setting up the application software

\* The QuickTime Player will launch, the readme file will open, and the Step 15 window will open. Click on the Close 1 and Close 2 buttons to exit the program.



[Close 1  
button]



[Close 2  
button]

15. A window where you can choose the program you want to install will appear. Click [Install]. For information on application software, please refer to page 94.



[Click !]

※ If you select [Cancel], the application program installation will be cancelled.

16. The [Digimax Viewer 2.1] installation window will be displayed as shown alongside. Click the [Next] button.



[Click !]

## INFORMATION

- If you select [Cancel] at step 16, a window for installing MGI PhotoSuite III SE will be displayed.

17. The Software License Agreement window will be displayed. If you agree to this, click [Yes], the window will then move to the next step. If you disagree, click [ No ] and the installation program will be canceled.

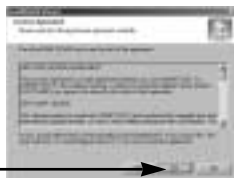

[Click !]

# Setting up the application software

18. A destination selection window will open. Click [Next >].

To copy to the files to another folder, click [Browse (R)..] and choose a folder you want.

[Click !]



19. A window will open, asking you to choose a folder to which program icons will be added. Click [Next >].

If you want to add the program icons to a different folder, choose another folder, and then click [Next >].

[Click !]



20. Installation is completed. Click the [Finish] button and a window for installing MGI PhotoSuite III SE will be displayed.

\* The computer will not restart even if I choose "Yes, I want to restart my computer now".

[Click !]



21. The [MGI PhotoSuite III SE] installation window will be displayed alongside. Click the [OK] button.

[Click !]



22. A [Welcome] window will be displayed.

Click the [Next >] button.

[Click !]



# Setting up the application software

23. The Software License Agreement window will be displayed. If you agree to this, click [Yes], the window will then move to the next step. If you disagree, click [No] and the installation program will be canceled.

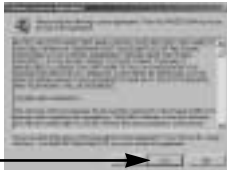
[Click !] → 

24. The [Choose Installation Type] window will open.  
Click [Next >].

[Full] : the program will be installed with all the options.  
[Custom] : you can choose what you would like to install.

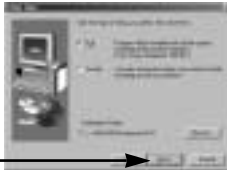
[Click !] → 

25. If installation is completed correctly, Autoplay is registered automatically into the start menu program as shown alongside. Click the [Next >] button.

[Click !] → 

26. The MGI Registration window will be displayed.  
Click the [Continue] button.

[Click !] → 

27. The [Online Registration Utility] window will be displayed.  
Fill in the blanks and click the [Register] button.

[Click !] → 

28. Installation is complete.  
Click the [Finish] button.

[Click !] → 

# Setting up the application software

\* The MGI III file will open.

Click on the Close button to close the window.



29. The Installation Wizard is finished now. Choose [Yes, I want to restart my computer now], and then click [Finish] to restart your PC.

Choose [No, I will restart my computer later], and then click [Finish] to restart your PC later.

※ To proceed with the installation of DigiStudio (an avatar creation program), choose [No, I will restart my computer later].



30. After restarting the computer, connect the PC to the camera with the USB cable.

31. Turn the camera power on. [Found New Hardware Wizard] will open and the computer will recognize the camera. If you have ever installed an image viewer program or your OS is Windows XP, an image viewer program will open. If the image viewer program opens, the camera driver was setup successfully.

32. If you can see [Removable Disk] under [My computer], the camera driver installation was successful. Now you can transfer image files from the camera to PC via the USB cable.



# Setting up the application software

## INFORMATION

- If you have installed the camera driver, [Found New Hardware Wizard] may not open.
- On a Windows 98 or 98 SE system, the Found New Hardware Wizard dialog box opens and a window asking you to select a driver file may appear. In this case, specify the [D:\Digimax U-CA3\Win 98FE\_SE Driver] folder on the supplied software CD.
- When connecting the camera to your PC, it is recommended that you use an AC power adapter.
- Before connecting the camera to the PC, You should first install the camera driver.
- After installing the camera driver, you have to restart your PC.
- If you connect the camera to the PC before installing the camera driver, the [Found New Hardware Wizard] will open.  
In this case, cancel the [Found New Hardware Wizard] and disconnect the camera. Install the camera driver and connect the camera to the PC again.
- Should the computer not find the camera driver after installation, please try one or more of the following measures.
  1. Delete the camera driver (p.108), and re-install the driver.
  2. Refer to FAQ (p.123) to check for a possible solution to the problem.
  3. If your PC's central processing unit is VIA chip (This is shown in the USB Host Controller), download the patch file from the Samsung Camera web page. (<http://www.samsungcamera.com>)



# DigiStudio Installation guide

## ■ System Requirements for DigiStudio

DigiStudio requires the following minimum system configuration for smooth 3D performance. If your system does not meet the requirements, you will receive error messages and the installation will not continue.

DigiStudio		
	Recommended System Requirements	Minimum System Requirements
CPU	Pentium III 500Mhz	Pentium II 400Mhz
RAM	128MB	64MB
Graphic Card	Graphic card with 3D acceleration and at least 16MB of video RAM	Graphic card with 3D acceleration and at least 8MB of video RAM
Sound Card	16 Bit Stereo Sound Card	
Hard Disk	150MB or more available space	
Operating System	Windows 98SE/2000/ME/XP	
Web Browser	Internet Explorer 5.0 or later	

## ■ System Requirements for DirectX 8.1

1. If your PC does not have DirectX (version 8.1 or later) installed, follow the instructions provided during the installation process to install DirectX.
2. If you are asked to confirm the installation of DirectX, click [Next >].
3. You will be asked to reboot after DirectX is installed.  
Once the installation of DigiStudio is complete, be sure to reboot your PC.

## ■ System Requirements for QuickTime

1. In order to view 3D avatars you created with DigiStudio in MOV format from the camera or PC, you must follow the instructions provided during the installation process and install the QuickTime Player (version 6.0 or later).
2. If you are asked to confirm the installation of QuickTime, click [Next >].
3. Please select the [Recommended] installation type.(p.106)

# DigiStudio Installation guide

## ■ Cautions on the Graphic Card (VGA)

The DigiStudio software will not install on a PO with a graphic card that does not support 3D acceleration and that has less than 8 MB video RAM. If the graphic card error screen appears while using DigiStudio, please go through the following steps:

**Step 1** : Go to My Computer → Control Panel → Display → Settings, check the display type and color palette settings.

**Step 2** : Set the color palette to High Color (16 bit) or True Color (32 bit).  
※ For Voodoo3 or Savage4, set the color palette to High Color (16 bit).

**Step 3** : The following graphic cards do not support 3D acceleration and cannot be used with DigiStudio:

- (1)ATI 3D (Charger /Pro Turbo /Xpression)/All in wonder pro
- (2)ATI Rage ( /iic)/Rage 3D(LT Pro /Pro)/Xpert (98 /@play)
- (3)nVidia Riva 128
- (4)3dfx Voodoo 2
- (5)SiS (6215A0 /6125B0 /6215C /5598 /530 /620 /540)
- (6)Intel i740 graphics chip
- (7)Hercules Terminator Beast
- (8)Trident 3D /Blade /CyberBlade
- (9)Diamond Multimedia FireGL 1000 Pro
- (10)Number 9 SR9

※ Depending on your graphics card, 3D avatars may not be supported.

**Step 4** : If the display type is set to Standard PCI Graphic Adapter (VGA), refer to the graphic card error screen and install the latest graphic card driver.



Graphic Card Error Screen



# DigiStudio Installation

- DigiStudio is a 3D avatar creation program. You can store 3D avatar files on the camera and use one of the avatars as the startup image.
- Be sure to check the system requirements (p. 103) before installing the program.
- This software is available in the Windows version only.
- Be sure to install the camera driver before transferring the avatars to the camera. (See page 95.)
- For instructions on how to use DigiStudio, please refer to Help.



1. When the installation screen shown on the right appears, click [Install].



2. An installation start window will open. Click [Next >].



3. The Language Selection window will open. Click [Next >].



4. The QuickTime 6.3 Installation window will open. Click [Next >].  
\*For more information on the QuickTime installation, please refer to page 95.

5. The Welcome window will appear. Click [Next >].

# DigiStudio Installation

6. The Software License Agreement window will appear, asking you to agree to the licensing. Use the button on the bottom left to select the language of your choice, and then click [Agree] to accept the license agreement. The installation will proceed to the next stage. If you do not agree to the license agreement, click [Disagree]. The installation will be canceled. If the language of your choice is not listed, please select [English].



7. The Choose Destination Location window will open. Click [Next >]. To copy the files to a different folder, click [Browse..] Browse to a folder you want to copy the files to.



8. The Choose Installation Type will open. Select [Recommended], and then click [Next >].



9. The Select Program Folder window will open. Click [Next >]. If you want to add the program icons to a different folder, choose another folder, and then click [Next >].



10. The Enter Registration window will open. Enter your name and organization in the respective fields, and then click [Next >]. You may skip the Registration Number field.



11. The QuickTime program folder will appear. Click on the Close button to close the folder.  
12. The Introduction window will open. Click [Next].

# DigiStudio Installation

13. The [Connection Speed] window will open. Click [Next]. To choose another transfer rate, click ▼ and select the desired transfer rate.
14. The Browser Plug-in window will open. Click [Next].
15. The File Type Association window will open. Click [Finish]. If you want to associate other file formats with QuickTime, put a checkmark (V) besides the file formats you want.
16. The Finished window will open. Click [Close].
- \* The QuickTime Player will launch, the readme file will open, and the DirectX 8.1 Installation window will open. Click on the Close button to exit the program.
17. The DirectX 8.1 Installation window will open. Click [Next >].

18. A window asking you to agree to licensing will open. Click [Yes] to agree to the license agreement. The installation will proceed to the next stage. If you do not agree to the license agreement, click [No]. The installation will be canceled.



19. The Folder Selection window will open. Click [Next >]. To copy the files to a different folder, click [Browse..] Browse to a folder you want to copy the files to.



20. Your installation is complete. Be sure to reboot your PC by clicking [Finish].



# Removing the USB Driver for Windows 98SE

■ To remove the USB driver, refer to the process shown below.

1. Trace [Start → Settings] and click [Control Panel].



2. Double-click [Add/Remove programs].

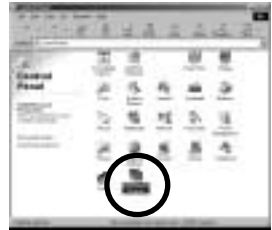

3. The [Add/Remove Programs Properties] window will open. Click [Digimax U-CA3 Camera] and click the [Add/Remove] button.

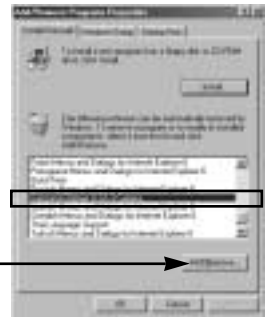

4. A window will open. Click the [OK] button and the camera driver will be removed.



5. Uninstallation is complete.

Click the [Finish] button and the window will disappear.



# Removable Disk

To use this camera as a Removable Disk, install (p.95) the USB Driver.

1. Before turning the camera power on, connect the camera to the PC with the USB cable.
2. Click [Removable Disk] under [My computer] or [Windows Explorer].
3. Image files stored in the Removable Disk (DCIM → 100SSCAM) can be transferred to the PC.

## INFORMATION

### Important information whilst using the Removable Disk

- The [Removable Disk] indicator will not show when the camera power is off.
- We recommend that you should copy the images to the PC to view them. Opening images directly from the removable disk may be subject to unexpected disconnection.
- When uploading images from the PC to the camera, ensure that the uploaded file names are not the same as those already stored on the memory.
- When you upload a file that is not taken by this camera to Removable Disk, the [FILE ERROR!] message will be displayed on the LCD monitor in the PLAY mode, and nothing is displayed in THUMBNAIL mode.
- The camera status lamp will blink, when a file is transferred (copy or deletion) between the PC and the camera. Do not remove the USB cable until the lamp stops blinking. To remove the USB cable in Windows 2000/ME/XP, use the [Unplug or Eject Hardware] icon on the task bar.

# Removing the removable disk

## ■ Windows 98SE

1. Check whether the camera and PC are transferring a file. If the function lamp blinks, you have to wait until the lamp illuminates.
2. Unplug the USB cable.

## ■ Windows 2000/ME/XP

(The illustrations may be different from the real display in accordance with the Windows O/S.)

1. Check whether the camera and PC are transferring a file. If the function lamp blinks, you have to wait until the lamp illuminates.
2. Double-click the [Unplug or Eject Hardware] icon on the task bar.



[Double-click]

3. The [Unplug or Eject Hardware] window will open. Select the [USB Mass Storage Device] and click the [Stop] button.



4. The [Stop a Hardware device] window will open. Select the [SAMSUNG DIGIMAX UCA3 USB Device] and click the [OK] button.

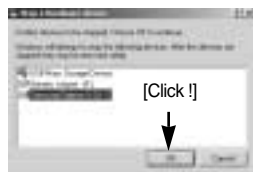

5. A [Safe to Remove Hardware] window will open. Click the [OK] button.



[Click !]

# Removing the removable disk

6. A [Unplug or Eject Hardware] window will open.  
Click the [Close] button and the removable disk will be removed safely.



7. Unplug the USB cable.

[Click !]

## Setting up the USB Driver for MAC

1. A USB Driver for MAC is not included with the software CD as MAC OS supports the camera driver.
2. Check the MAC OS. You can check the MAC OS version during MAC OS start-up.  
This camera is compatible with MAC OS 9.X~10.2.
3. Connect the camera to the Macintosh and turn the camera power on in PC mode.
4. A new icon (Untitled) will be displayed on the desktop after connecting the camera to the MAC.

## Using the USB Driver for MAC

1. Double click a new icon (Untitled) on the desktop and the folder in the memory will be displayed.
2. Select an image file and copy or move it to MAC.

## INFORMATION

- If you use Mac OS 10.0 or later, you may experience an error occurring when you transfer files from the PC to the camera.
- If you cannot play a video in MAC OS 9.x, check the version of your QuickTime Player.  
If your version of QuickTime Player is earlier than 5.x, then install a version 6.0.3 or later. To install QuickTime Player, use the supplied CD-ROM or download a free version from the Apple site at <http://www.apple.com>.

# Digimax Viewer 2.1

This software is only compatible with Windows.



1. To open Digimax Viewer, click the [Start → Programs → Samsung → Digimax Viewer 2.1 → Digimax Viewer 2.1 ] and Digimax Viewer 2.1 will then open.

2. If the [Auto Launch] option is selected, this program will be executed automatically with recognizing the camera.



3. You can easily use the Digimax viewer 2.1 program as it offers a FILE menu and TOOL bar. And, you can use the pop up menu. Click an image and press the right mouse button.

Digimax Viewer functions are listed below.

- Basic functions : Copy, Move, Delete, Rotate, Rename, changing file type, Resize, Property.
- Advanced functions : Print, Slide show, Export, Sending e-mail, On-line print, Web album etc.

## INFORMATION

- Before deleting images from the camera, you should protect or download images to your computer that you wish to keep.
- Refer to the [Help] menu in Digimax viewer 2.1 for further information.









# MGI PhotoSuite III SE

This software is only compatible with Windows.

To open MGI PhotoSuite III SE, click the [Start → Programs → MGI PhotoSuite III SE → MGI PhotoSuite III SE] and MGI PhotoSuite III SE will then open.









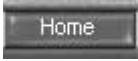

## ■ An introduction to the Welcome screen

	<p>Get</p> <p>Get images.</p>
	<p>Prepare</p> <p>A number of photo editing activities can be performed within this module.</p>
	<p>Compose</p> <p>Use your photos in a variety of fun, creative and interesting ways.</p>
	<p>Organize</p> <p>Organize your photos and other media files into albums.</p>
	<p>Share</p> <p>Save your results to show to others.</p>
	<p>Print</p> <p>Print hard copies of photos and projects.</p>

# MGI PhotoSuite III SE

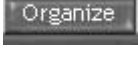
## ■ Introduction to navigation bar



	<b>Back</b> Return to the previous step.
	<b>Home</b> Return to Welcome screen.
	<b>Help</b> Display help window.
	<b>Get</b> Get images.
	<b>Prepare</b> A number of photo editing activities can be performed within this module.
	<b>Compose</b> Use your photos in a variety of fun and interesting ways.
	<b>Organize</b> Organize your photos and other media files into albums.
	<b>Share</b> Save your results to show to others.
	<b>Print</b> Print hard copies of photos and projects.
	<b>Browse</b> Browse the web site.

# MGI PhotoSuite III SE

## Get

### ■ To obtain images from the computer

1. To acquire images, Click the large [Get] button on the Welcome screen, or the [Get] button on the Navigation bar. Click [Computer] from the list of options displayed on the activity panel.



2. The Open file selector is displayed. Now select the image file and click [open].



3. The Welcome screen will change to the next work step, with the selected image displayed.



### ■ When you obtain images from the digital camera.

Before transferring an image file, check the USB connection.

1. To acquire images, click the large [Get] button on the Welcome screen, or the [Get] button on the Navigation bar. Click [Computer] from the list of options displayed on the activity panel.



2. The Open file selector is displayed. Click [Look in :] to choose [Removable Disk( :)] and click [open] for the open file window to be displayed.



# MGI PhotoSuite III SE

3. Select the [ DCIM → 100sscam ] folder.  
Then select an image and click [ Open ].



4. The Welcome screen will change to the next work step, with the selected image displayed.



## NOTICE

When you use the Digimax camera, only [Computer] and [Album] from the list of options displayed are available.

You will be able to obtain images from the digital camera.



[Computer and Album Only]

### ■ Acquiring images from an Album.

1. To acquire images, click the large [Get] button on the Welcome screen, or the [Get] button on the Navigation bar. Click [Album] from the list of options displayed on the activity panel.



# MGI PhotoSuite III SE

2. After selecting Album on the [①Choose a photo album], click an image in the album and click [Open].

3. The Welcome screen will change to the next work step, with the selected image displayed.

※ Refer to page 120 for more information about creating an Album.



## Prepare

When the image is loaded, the step changes to Prepare automatically.

### ■ Menu for [PREPARE] steps

#### Rotate & Crop

You can rotate, flip or crop images along with a host of others.



#### Touchup

Remove Red eye, Remove Scratches etc.. are available in this menu.

#### Special Effects

A number of special effects can be applied.

#### Stitching

Join a series of photos together to create a sweeping panoramic effect.

## Compose

Add text, Compound Images etc. are available in this step.

### ■ Menu of [COMPOSE] steps

- Collages** : A collage consists of several photos or sections of photos arranged together on a common background.
- Photo Layouts** : The Photo Layouts activity includes many collage and layout options.
- Cards & tags** : Use your photos to create items such as Gift Tags, Greeting Cards, Invitations, Postcards, and Sports Cards.
- Calendars** : Use your photos to create a variety of calendars (monthly, quarterly, seasonal, yearly).
- Collections** : Photos can also be used to create a variety of items for business purposes.
- Fun stuff** : You can create magazine covers, Backgrounds etc. in this menu.
- Business** : You can make business items such as business cards, certificates, signs, labels, promotions, name tags, stationary
- Frames & Edges** : Add frames and edge effects to your photos according to predefined templates.



## Organize

Organize your photos and other media files into albums.

### ■ Menu of [ORGANIZE] steps

[① Choose a photo album to view or edit]

Select Album: To create an Album, click [Organize] in the welcome screen or navigation bar.

Album.: Open Master Album.

[② Select a photo, and choose an action below.]

- Open : Open selected image.
- Delete : Delete selected image.
- Properties... : view image information.

[③ Choose an action to manage your album.]

- Add : click [Add] to add an image to an Album.
- Sort : click [Sort] to Sort saved images.
- Search : click [Search] to Search saved images.
- Reset : click [Reset] to reset the setting.
- Update : click [Update] to update images.
- Create Slide Show : click [Create Slide Show] to create a Slide Show.

Always start on this page : If you select this option, the program will start in [Organize].



# MGI PhotoSuite III SE

## ■ Creating an Album

1. To create an Album, click the large Organize button on the Welcome screen, or the Organize button on the Navigation bar.

2. Click [Album..] in [Choose a photo album to view or edit.]

[Click!]



3. The Master Album window will be displayed, then click [New..].

[Click!]

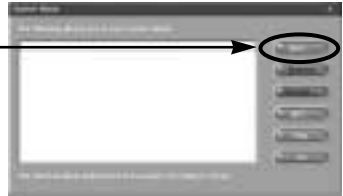

4. Put a new Album name in the New Album window and click [OK]. A new album will now be created.

[Click!]



5. A [Master Album] window will open. Click the [OK] button.

[Click!]





# MGI PhotoSuite III SE

## ■ Add images to the album

1. Select [**3** Choose an action to manage your album. → Add..] to add images to the album.

[Click!] →

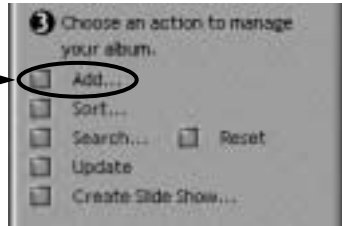

2. Click [Computer] in Add Photos menu.  
[Digital Camera(Direct)], [Scanner(TWAIN)],  
[Digital Camera(TWAIN)] sources can't be used.

[Click!] →



3. A [Add photo to Album] window will open.  
Select images that you want to add.  
Click the [Add] button.

[Click!] →



4. Adding images is complete.



# MGI PhotoSuite III SE

## Share

Saving or sharing images.

### ■ Menu of [SHARE] steps

#### Save

To save the active file according to its current name and path.

#### Save As

To assign a new name or path to the file.

#### Send E-mail

e-mailing images.

#### Slide Show

Viewing images as a slide show.



## Print

You can print images.

### ■ Menu for the [PRINT] steps

#### Print

Printing images.

#### Print Multiples

Print multiple copies of a photo or project, or one copy of each of the photos included in an album, according to a predefined template.

- \* Choose a printer, an orientation, the print size, and the number of copies.

You can then print the images.



## INFORMATION

- For more information, please refer to the Help file in [Help MGI PhotoSuite III help].

# FAQ

Please check the following if the USB connection malfunctions.

[Case 1]

The camera power is off.

- Turn the camera power on. We recommend using an AC power adapter in PC mode.

[Case 2]

USB Driver is not installed correctly.

- Install the USB Driver correctly. Refer to page 95.

[Case 3]

The USB cable is not connected or you are using a cable with an incorrect specification.

- Use a USB cable with the correct specification.

[Case 4]

The camera is not recognized by your PC.

Sometimes, the camera may appear under [Unknown Devices] in Device Manager.

- Install the camera driver correctly.  
Turn off the camera, remove the USB cable, plug in the USB cable again, and then turn on the camera.

[Case 5]

There is an unexpected error during file transfer

- Turn the camera power off and on again. Transfer the file again.

[Case 6]

How do I know my computer supports a USB Interface?

- Check the USB port in your computer or keyboard.
- Check the OS version. A USB Interface is available in Windows 98, 98SE, 2000, ME .XP.
- Check [Universal serial bus controller] in Device Manager. Do the following to check [Universal serial bus controller].  
Win 98/ME : Trace [Start → Setting → Controller → System → Device Manager → Universal serial bus controller]  
Win 2K : Trace [Start → Setting → Controller → System → Hardware → Device Manager → Universal serial bus controller].

Win XP : Trace [Start → Control Panel → Performance and Maintenance → System → Hardware Device Manager → Universal Serial Bus controller].

There must be USB Host Controller and USB root hub under [Universal serial bus controller].

- When all the conditions mentioned above are met, the computer can support the USB interface.

## [Case 7]

When using the USB hub.

- There may be a problem in connecting the camera to the PC through the USB hub if the PC and the hub are not compatible. Wherever possible, connect the camera to the PC directly.

## [Case 8]

Are other USB cables connected to the PC?

- The camera may malfunction when it is connected to the PC at the same time as another USB cable. In this case, disconnect the other USB cable, and connect only one USB cable to the camera.

Please check the following if you encounter a problem while running DigiStudio.

## [Case 1]

My PC slows down when I launch DigiStudio.

- Check the system requirements for the installation of DigiStudio. If your PC does not meet the recommended system requirements for the installation, your PC may run slowly.

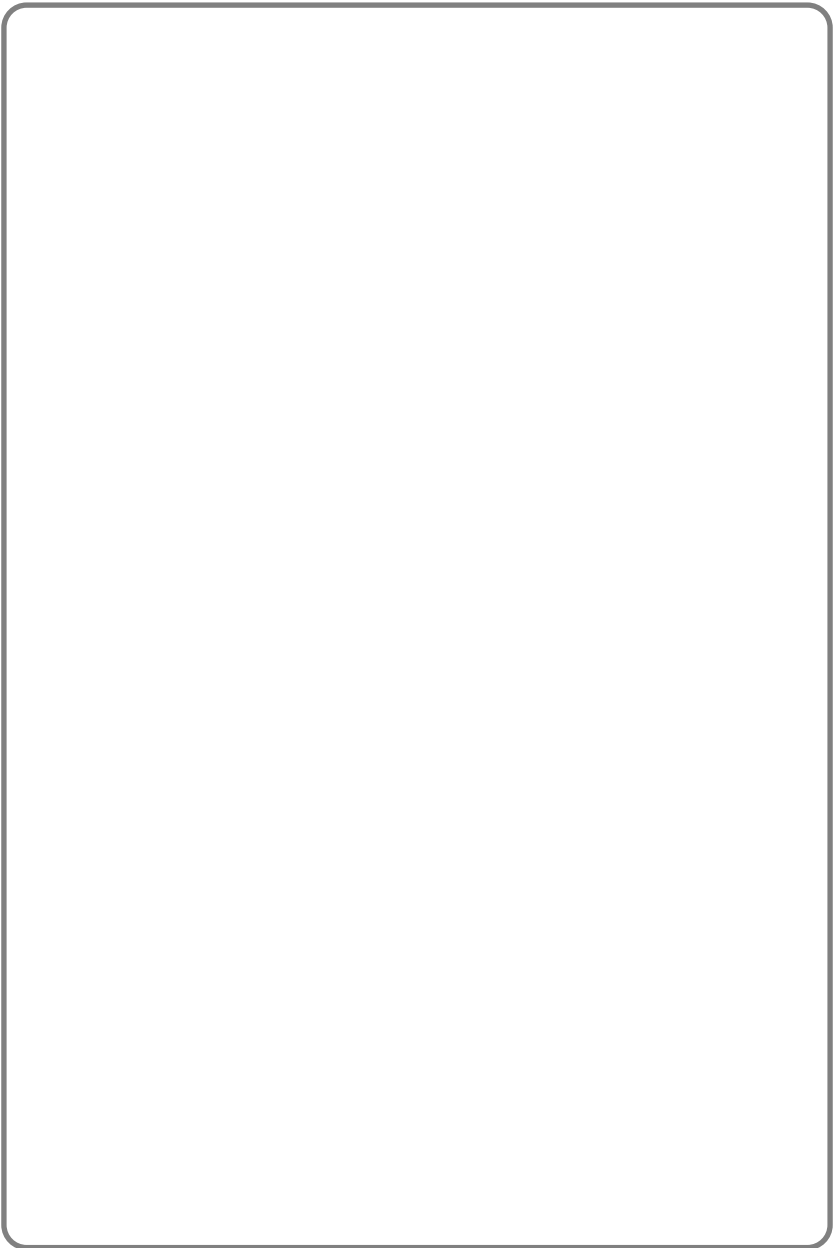

# MEMO

# MEMO

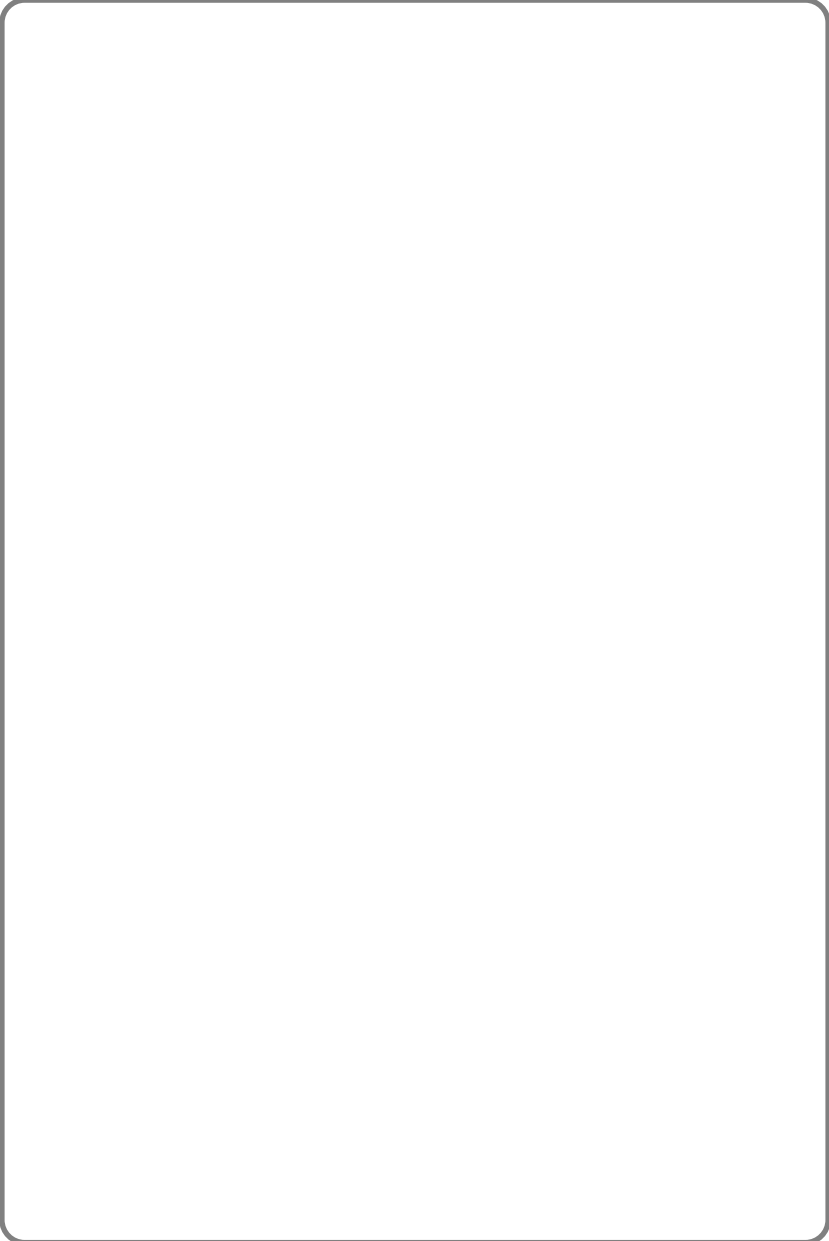



SAMSUNG TECHWIN CO., LTD.  
OPTICS & DIGITAL IMAGING DIVISION  
145-3, SANGDAEWON 1-DONG, JUNGWON-  
GU, SUNGNAM-CITY, KYUNGKI-DO, KOREA 462-  
121  
TEL : (82) 31-740-8086, 8088, 8090, 8092, 8099  
FAX : (82) 31-740-8398, 8111

SAMSUNG OPTO-ELECTRONICS AMERICA, INC.  
HEADQUARTERS  
40 SEAVIEW DRIVE, SECAUCUS, NJ07094, U.S.A.  
TEL : (1) 201-902-0347  
FAX : (1) 201-902-9342

WESTERN REGIONAL OFFICE  
18600 BROADWICK ST.,  
RANCHO DOMINGUEZ, CA 90220, U.S.A.  
TEL : (1) 310-537-7000  
FAX : (1) 310-537-1566

SAMSUNG OPTO-ELECTRONICS UK LIMITED  
SAMSUNG HOUSE  
1000 HILLSWOOD DRIVE  
HILLSWOOD BUSINESS PARK  
CHERTSEY KT16 OPS U.K.  
TEL : +44 (0) 1932 455000  
FAX : +44 (0) 1932 455325

SAMSUNG OPTO-ELECTRONICS GMBH  
AM KRONBERGER HANG 6  
D-65824 SCHWALBACH/TS., GERMANY  
TEL : (49) 6196 66 53 03  
FAX : (49) 6196 66 53 66

SAMSUNG FRANCE S.A.S.  
BP 51 TOUR MAINE MONTPARNASSE  
33, AV .DU MAINE  
75755, PARIS CEDEX 15, FRANCE  
HOTLINE PHOTO NUMÉRIQUE :  
00 800 22 26 37 27 (Numéro Vert-Appel Gratuit)  
TEL : (33) 1-4279-2282/5  
FAX : (33) 1-4320-4510

SAMSUNG TECHWIN MOSCOW OFFICE  
KORP. 14 37-A LENNINGRADSKY PR-KT  
MOSCOW, 125167, RUSSIA  
TEL : (7) 095-258-9296, 9298, 9299  
FAX : (7) 095-258-9297

TIANJIN SAMSUNG OPTO-ELECTRONICS CO.,LTD.  
7 PINGCHANG ROAD NANKAI DIST., TIANJIN  
P.R CHINA  
POST CODE:300190  
TEL : (86) 22-2761-8867  
FAX : (86) 22-2761-8864

\* Internet address - [http : //www.samsungcamera.com/](http://www.samsungcamera.com/)



The CE Mark is a Directive conformity  
mark of the European Community (EC)

6806-1671